

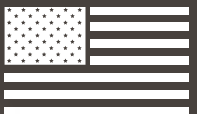

**Unleash Your Full Cleaning Potential**

Phone: 262-833-4025 Toll Free: 855-965-0011 [www.kodiakequip.com](http://www.kodiakequip.com)



**Full Range Handmade In Wisconsin, USA**

# SPECS



- Up to 176,000 sqft Per Charge
- 45 / 46 Gallons
- 26 - 32 inch decks

### Applications

- Fabrication Shops
- Auto-Truck Dealers
- Machine Shops

# K42 v2

<b>Disk Scrub Path:</b>	28" & 32" 71 & 81 cm
<b>Cylindrical:</b>	26" & 30" 66 & 76 cm
<b>Dimensions (L×W×H):</b>	62" x 36" x 52" 158 x 92 x 133 cm
<b>Step Up Height:</b>	17" 43 cm
<b>Solution Tank:</b>	45 Gal 170 L
<b>Recovery Tank:</b>	46 Gal 174 L
<b>Demisting Chamber:</b>	125 Gal 4 L
<b>Run Time:</b>	Up to 4 Hours*
<b>Theoretical Coverage:</b>	44,000 sqft/hr* 4,087 sqm/hr*
<b>Practical Coverage:</b>	20,500 sqft/hr* 1,904 sqm/hr*



### Fits through 31" Entryways

- Up to 154,000 sqft Per Charge
- 22 / 23 Gallons
- 20 - 28 inch decks

### Applications

- Warehouse
- Food & Beverage
- Manufacturing

# K22R

<b>Disk Scrub Path:</b>	20" & 26" 51 & 66 cm
<b>Orbital:</b>	24" & 28" 61 & 71 cm
<b>Dimensions (L×W×H):</b>	54" x 27" x 40" 138 x 69 x 102 cm
<b>Step Up Height:</b>	11" 28 cm*
<b>Solution Tank:</b>	22 Gal 83 L
<b>Recovery Tank:</b>	23 Gal 87 L
<b>Demisting Chamber:</b>	0.75 Gal 3 L
<b>Run Time:</b>	Up to 4 Hours*
<b>Theoretical Coverage:</b>	38,500 sqft/hr* 3,576 sqm/hr*
<b>Practical Coverage:</b>	18,000 sqft/hr* 1,672 sqm/hr*

# SCRUB DECKS

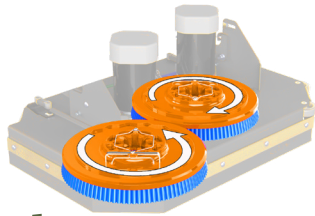

## Disk

- Brush / Pad Selection
- Lowest Maintenance Cost
- Improved Cleaning on Irregular Floors
- Brushes Individually Driven for Unmatched Performance

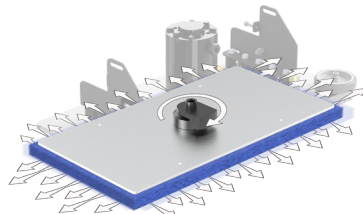

## Orbital \*K22R ONLY

- Chemical Free Stripping
- Reduce Slip & Fall Potential
- 70% Reduction in Water Usage
- Consistent Results - No Swirl Marks
- VCT Prep & Recoat

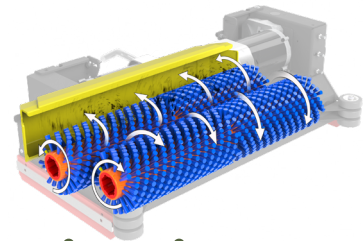

## Cylindrical \*K42 v2 ONLY

- Eliminates Dust Mopping
- Scrub & Sweep Simultaneously
- Superior Tile & Grout Cleaning
- Excellent on Rubber Surfaces
- Great for Warehouse Debris

# OPTIONS



**Auxiliary Tank + 100 psi Spray Gun**  
Use your preferred disinfectant or degreaser to clean a wide range of surfaces. Desks, counter tops, chairs ect.

**\*AUXILARY TANK K22R ONLY**

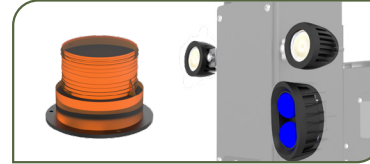

### Lights

Designed to increase visibility during operation in low-light conditions. Strobe, Blue light, and dual LED headlights.

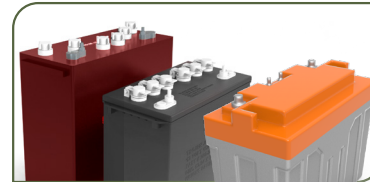

### WET / AGM / Lithium Battery Options

Choose between a variety of battery options for optimal run and charge times based on the application and needs.

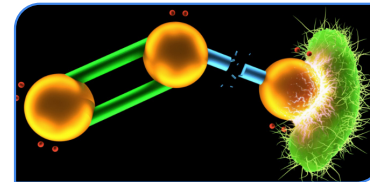

### ZERO3 Chemical Free Cleaning

Replace all-purpose floor cleaner with one of Earth's most powerful oxidizers - On Demand Aqueous Ozone.

- Clean with water & Ozone alone
- Safe, affective and sustainable

**\*K22R ONLY**

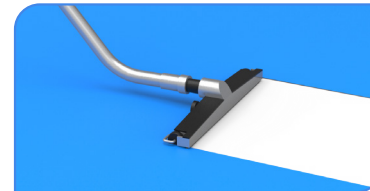

### Vac Wand

ideal for water pick up in restrooms and reaching under tables.

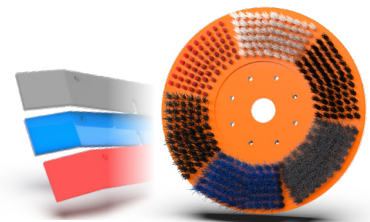

### Squeegee Blade / Brush Choice

Different Materials to fit the job

- NanoRade®
- Urethane
- Linatex®
- 5 Brush Fibers + Pad Driver

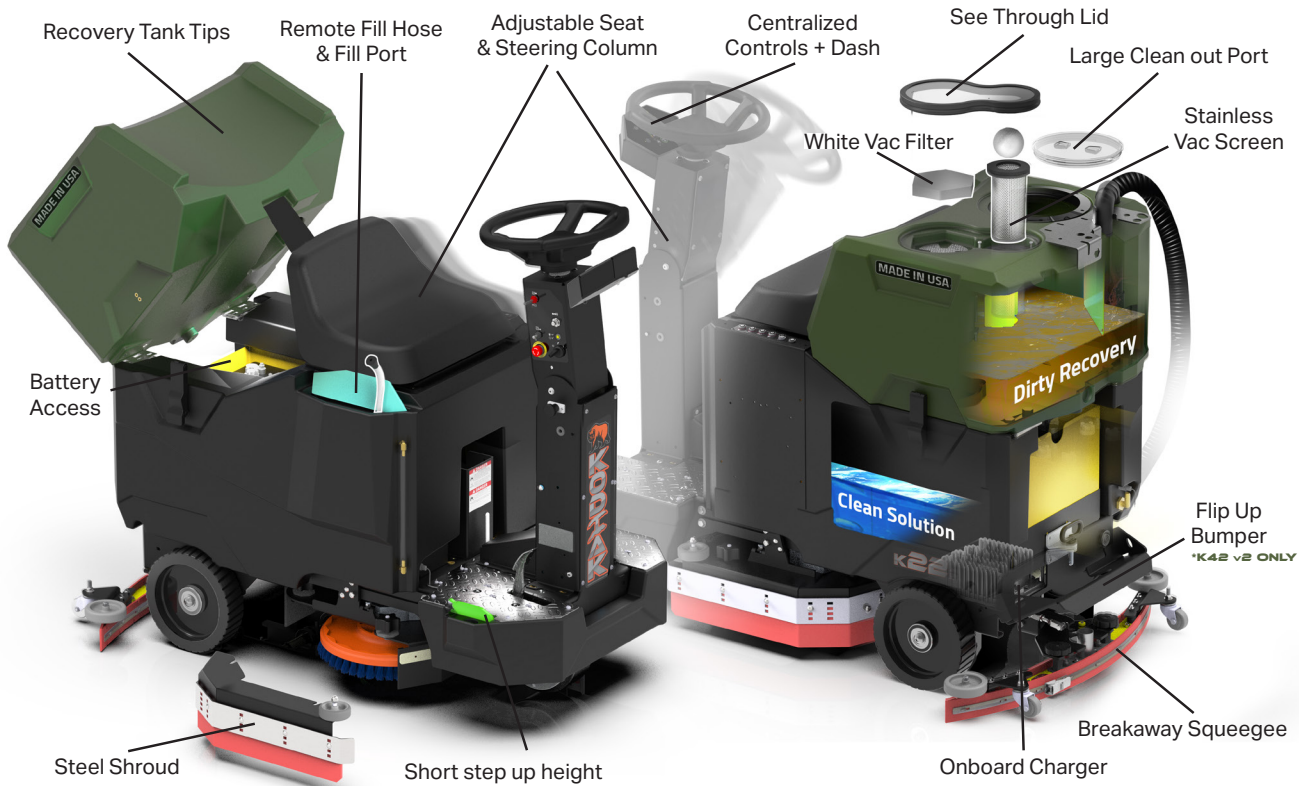

## Warehouse



Our scrubbers are popular in warehouses and distribution centers for their efficiency and scrubbing performance. They clean dusty floors thoroughly while leaving them dry and safe.

## Food & Beverage



The high cleanliness standards of the food and beverage industry necessitate the use of innovative floor scrubbing solutions to ensure a safe and hygienic environment for both production and consumption.

## Manufacturing



As a large manufacturer we understand the unique needs of production companies. We provide equipment that manages the cleaning requirements arising from the processing of various materials like steel, plastics and wood.

# ALL STEEL FRAME

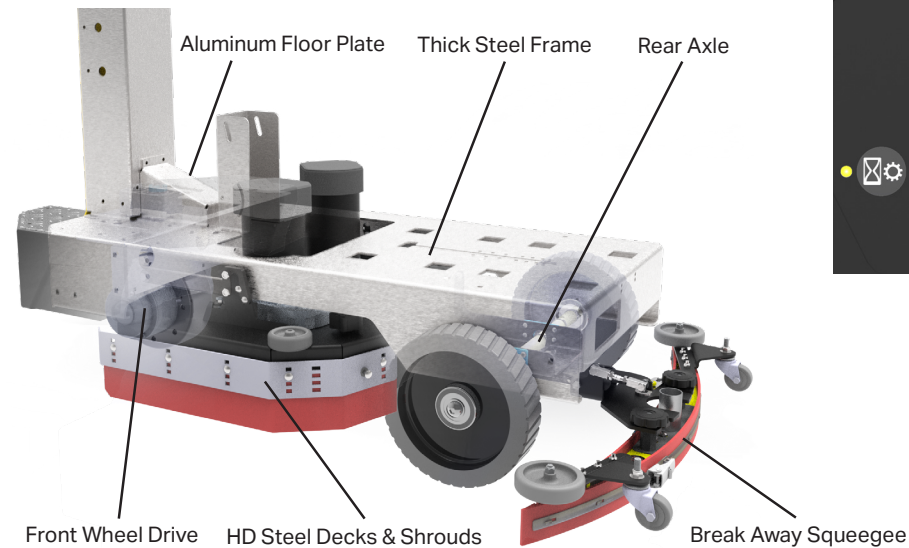

# MEMBRANE & LCD

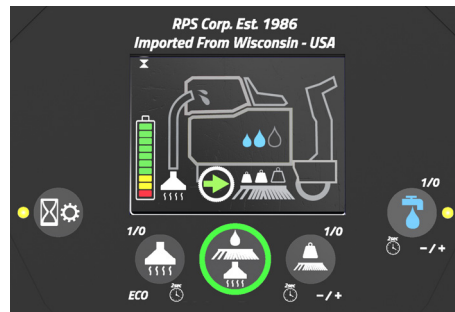

- Easy Scrub Button
- Eco Mode
- 3 Hour Meters
- Three Scrub Pressure Settings
- Three Water Settings
- Service Screen

# Our Family's American Dream

RPS has been family owned from its inception in 1986, and proudly builds in Wisconsin (USA). The company has grown over the last 35-years with a strong group of executives including the 2nd generation of family owners who started in the shop as youngsters.

Authorized Distributor



## Assembled By Hand

Our American workforce hand-builds each machine with components sourced heavily from American suppliers. We routinely pay more for these domestically supplied components required to build a superior product. All design, prototyping, production and testing is done in-house where we can best control quality.



## Steel Fabrication

We produce heavy duty equipment and require a good amount of thick steel in the construction. We use a combination of Stainless 304 (Austenitic 18/8) and mild steel with e-coating + powder paint for corrosion resistance. Steel fabrication is done in-house or from local suppliers with specialty equipment.



## Rotational Molding

Complex shapes that allow for our tank designs are best achieved with in-house equipment. We own multiple dual station rotational molding machines that allow us to produce finished parts from raw plastic. Producing consistently higher quality parts, and respond quickly to sales spikes.



## Product Design

Our team has designed and engineered over 100 unique machines. Each new generation of machines evolve from prior designs to retain the strengths and correct any weakness. From the first pencil sketch we focus on durability, serviceability, performance, productivity, specifications, and value.