



K42 V2

Operator Manual (EN)

Models:

28", 30" & 32" Disk
26" & 30" Cylindrical

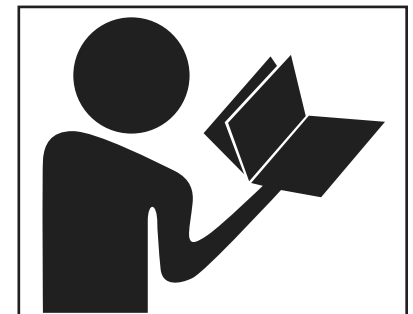
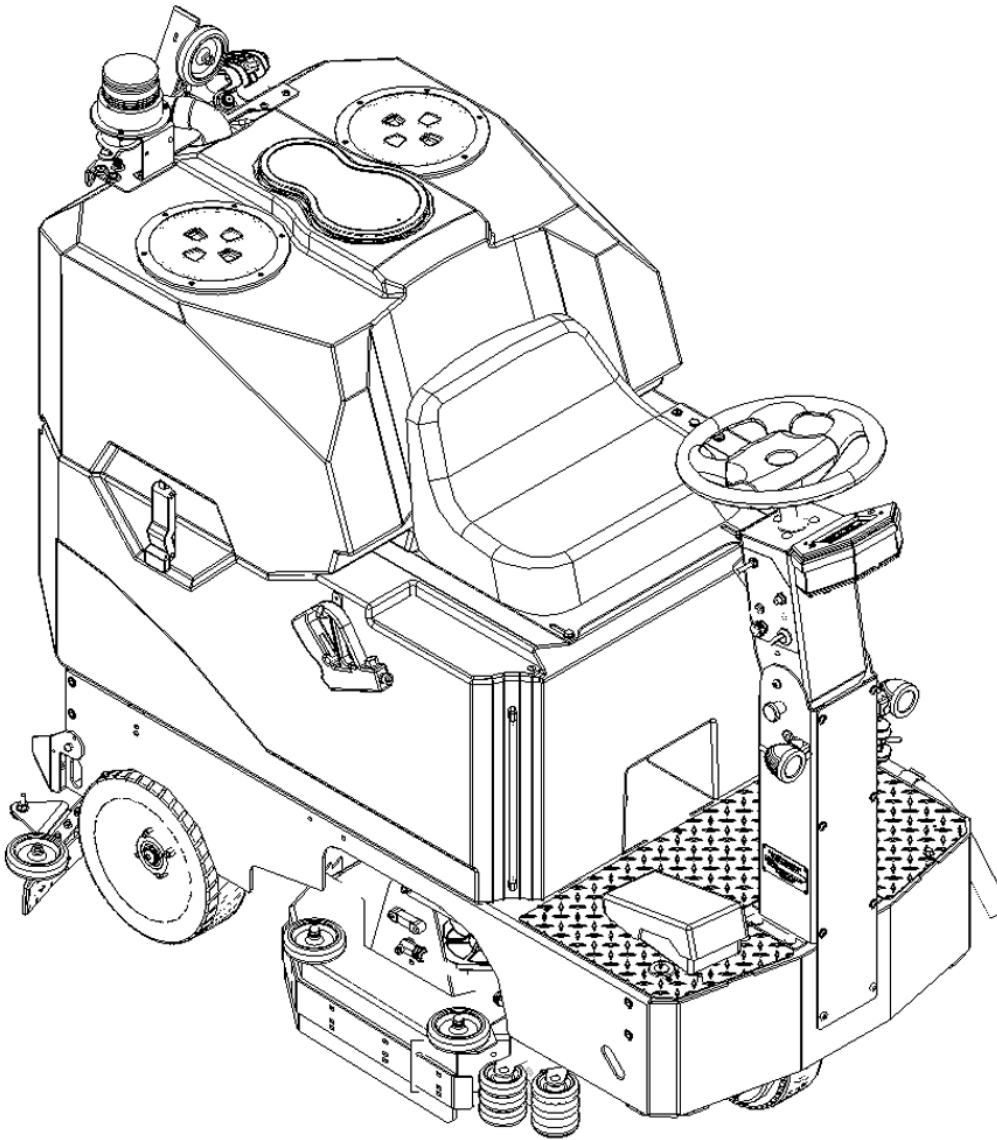

Read the Operators Manual
before using the machine.



Read the Safety Messages
before servicing machine.

INTRODUCTION

This manual is furnished with each new machine. This manual will allow the Operator to get the best performance out of your RPS manufactured Scrubber-Drier, Sweeper, Burnisher, or Orbital Scrubber. Read this manual thoroughly before operating or servicing the machine.

This machine will provide excellent performance, but the best results will be obtained at the most minimum costs if:

- The machine is regularly maintained - per the Authorized Local Distributor.
- The machine is operated with reasonable care and caution.
- The machine is maintained with manufacturer supplied parts.

Locate Serial Number

The serial number of your machine is located on the lower half of the control panel of the machine.

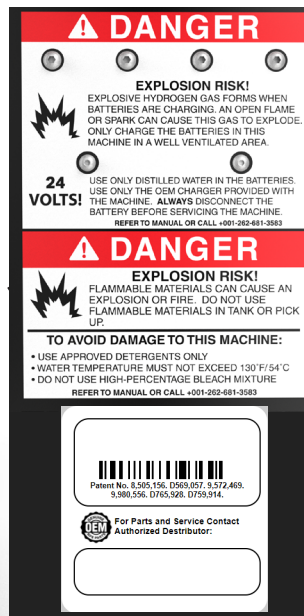

SAFETY LABELS

Read and obey all Safety Labels on your equipment. If you have questions about these labels, ask your supervisor.

These images indicate where on the Safety Labels are located. If ever the labels become illegible, worn off, or torn, promptly report it to your supervisor and replace it.

AS OUR POLICY IS ONE OF CONSTANT IMPROVEMENT - ALL INFORMATION AND SPECIFICATIONS ARE SUBJECT TO CHANGE WITHOUT NOTICE.

Intended use

The Kodiak K42 v2 Ride On Floor Scrubber is intended for industrial applications with hard floor surfaces such as concrete, VCT, tile and grout, stone, ect. This machine is not designed to clean carpets or sand wooden surfaces. Use only OEM pads/brushes and commercially available floor cleaning detergents. Do not use this machine other than described in this Operator Manual.

Machine Data

Fill out while installing machine for future reference.

Model No. - _____

Serial No. - _____

Installation Date - _____

Uncrating Machine

Inspect machine for damage before unloading, if any damage has occurred report it to the carrier. Contact distributor or RPS Corp. for missing components.

Remove protective shipping frame then locate and unscrew the metal bracket connecting the machine to the pallet. Before removal the scrub head should be in the raised position. Using the supplied ramp carefully back the machine off the pallet.

RPS Flooded Lead Acid (FLA) & Absorbed Glass Mat (AGM) Battery Warranty

Dear customer, We are honored that you have purchased one of our battery-powered floor machines. As you know the batteries in your machine are the heart of the machine and what makes it go. The batteries require proper care and maintenance throughout their life. Here are some important things you need to know.

Batteries need to be “Broken In”. This means that they will not yield their full capacity until you have used them and charged them properly, in some cases 20 – 40 complete charge cycles. Depending on the battery's state of discharge, complete charges may require 12+ hours of uninterrupted charging. The charger will then indicate a completed charge cycle on the charger's LED display.

Batteries need proper care while in use or when left idle for extended periods. With Flooded Lead Acid (FLA) this means weekly electrolyte level inspection, adding distilled water if needed, and charging them completely after every use. Adding water to FLA batteries already damaged from being run low won't repair them but will prevent further damage to that cell. The need to add water to cells varies based on application, environment, use, and brand, that is why we suggest frequently checking electrolyte levels. Batteries need monthly maintenance charges if not used/left idle. Plug in the charger to re-start the charge cycle. FLA and AGM batteries should always be stored fully charged.

Batteries have cycle and age limitations. Whether you are using them or not, batteries are aging from self-discharge. Batteries also age with every charge and discharge cycle, which are limited. From 250-300 cycles on some batteries, 650-700 on others. We offer a range of battery upgrades (brands, sizes, and types) and depend on the distributor to cover these battery traits and care details with their customers/end-users.

What happens when batteries seem weak or run time feels reduced? There may or may not be an issue, which requires diagnosis and that means testing, which takes time and proper tools (multi-meter, hydrometer for Specific Gravity readings, discharge testing tool).

If you have questions call 262-833-4025

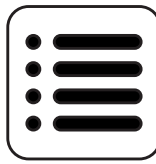

INTRODUCTION

Intended use 2
Machine Data 2
Uncrating Machine 2
Battery Warranty 3

SAFETY

Important Safety Messages 5
Safety Labels 6

OPERATION

Machine Overview 7
Central Command Overview 8
Membrane Operation 9
Touch Screen Operation (Optional) . . 10
Parking Brake 15
Steering Controls 16
Headlights (Optional) 17
Spray Jet Controls (Optional) 18
Battery Setup 19
Squeegee Installation 20
Squeegee Adjustment 21
Forward Drive 22
Reverse Drive 23
Fill Solution Tank 24
Scrubbing 25
Drying 26
Drain Recovery 27
Flushing Recovery Tank 28
Utility Bracket (Optional) 29
Charge Batteries 30

WEEKLY MAINTENANCE (OR 25 HRS)

Clean White Filter/Screen 31
Rotate Disk Brushes 32
Rotate Cylindrical Brush 33

DAILY MAINTENANCE

Clean Cylindrical Hopper 34
Clean Solution Filter 35
Rotate Squeegee Blade 36
Drain Solution Tank 37

MONTHLY MAINTENANCE (OR 100 HRS)

Adjusting Deck Sidewipers 38
Battery Water Level 39

OTHER

PM Sheet 40
Battery Chargers 42

ERROR CODES

Membrane 43
Touch Screen (Optional) 45

Important Safety Messages

You will see four kinds of safety reminders in this manual:

<p style="text-align: center;">⚠ DANGER</p> <p>DANGER indicates a hazardous situation which, if not avoided, will result in death or serious injury.</p>	<p style="text-align: center;">⚠ WARNING</p> <p>WARNING indicates a potentially hazardous situation which, if not avoided, could result in death or serious injury.</p>
<p style="text-align: center;">⚠ CAUTION</p> <p>CAUTION indicates a potentially hazardous situation which, if not avoided, could result in minor or moderate injury or damage to this machine or nearby objects. CAUTION also can be used to alert against unsafe practices.</p>	<p style="text-align: center;">NOTICE</p> <p>NOTICE indicates information considered important, but not hazard-related. This safety message may be related to property damage or warranty warnings.</p>

Your safety, and that of others, is very important. Operating this machine safely is an important responsibility.

DO NOT OPERATE THIS MACHINE:

- Unless you are trained and authorized to do so by your RPS Authorized Local Distributor
- Unless you have read and understood this Operator’s Manual
- On surfaces with greater than a 3° slope.
- Within 25’ (8m) of Loading Docks

WHEN OPERATING THIS MACHINE:

- Remove loose objects from the floor that could be projected from the rotating Brushes
- Keep your hands and feet away from the rotating Brushes
- Do not operate this machine where flammable liquids, vapors, or dust are present
- Use caution when maneuvering

BEFORE LEAVING THE MACHINE:

- Drain “clean” Solution & “dirty” Recovery solution into APPROVED drains
- Park the machine on a level surface
- Turn the machine off & remove key

BEFORE SERVICING THE MACHINE:

- Disconnect the Batteries
- Wear PPE



<p style="text-align: center;">⚠ DANGER</p> <p>Explosive hydrogen gas forms when Batteries are charging. An open flame or spark can cause this gas to explode. Serious personal injury or property damage could occur. Only charge the Batteries in this machine in a well ventilated area.</p>	<p style="text-align: center;">⚠ DANGER</p> <p>Flammable materials can cause an explosion or fire. Do not use flammable materials in Tank or pick up.</p>
--	--

SAFETY

⚠ WARNING

The Batteries in this machine produce hazardous voltage which can cause electrical shock, burns and/ or electrocution. Always disconnect Batteries before servicing this machine.

⚠ WARNING

When climbing or descending ramps, always drive machine forward. To avoid overturning the machine, Do not back down ramps. Do not drive across inclines. Do not turn while ascending or descending ramps. Overturning the machine can cause serious injury or death.

⚠ WARNING

Do not use water that exceeds 135°F / 57°C. If water is above said temperature, this will void the Tank Warranty.

⚠ WARNING

Do not park this machine on ramps or slopes. Always park this machine on a level, hard surface. Do not operate this machine outdoors or on uneven surfaces.

⚠ WARNING

The Batteries in this machine contain sulfuric acid, which causes burns to skin. If battery acid contacts clothing or skin, rinse the effected area with cold water immediately. If battery acid gets on your face or in your eyes, flush the area immediately with cold water and seek medical attention.

⚠ WARNING

To avoid electrical shock, do not operate this machine over electrical floor outlets.

⚠ CAUTION

To avoid damage to this machine, use only cleaning solutions and replacement parts recommended by the manufacturer.

⚠ CAUTION

Do not operate this machine if any parts have been damaged or removed.

⚠ WARNING

Dress safely. Do not wear rings or metal wrist watches when servicing this machine, as they can cause an electrical short circuit which can cause serious burns.

⚠ WARNING

Do not remove, paint over or destroy warning decals. If warning decals become damaged, call 1-262-681-3583 for free replacements.

⚠ WARNING

Dress safely. Do not wear a neck tie, scarf, or any loose or dangling clothing while operating this machine. Loose or dangling clothing or neck-wear can tangle in rotating parts, causing serious injury or death.

⚠ WARNING

Always turn off this machine before leaving it unattended. Do not allow untrained persons to operate this machine.

⚠ WARNING

NO RIDERS. Do not carry passengers on this machine. Do not use this machine as a stepladder or work platform.

⚠ WARNING

Understand the dynamic braking system before you operate the machine on ramps. Machine may coast.

⚠ WARNING

Before you service a Battery, always wear face protection, protective gloves and protective clothing. Battery acid or battery explosion can cause serious injuries.

⚠ CAUTION

Always use the automatic battery charger provided by the manufacturer of this machine to charge the Batteries of this machine. It is designed to charge the Batteries at the appropriate rate. If you must use a different charger, disconnect the Batteries before charging to avoid damage to the electronic speed controller.

⚠ CAUTION

To avoid damage to the electronic control components of this machine, Do not store this machine outdoors. Do not pressure wash this machine.

Machine Overview

1. Recovery Tank
2. Solution Tank
3. 4x 6VDC Batteries (24vdc System)
4. Control Toggles
5. Dashboard
6. Foot Pedal
7. Electrical Panel
8. Vac Motor
9. Squeegee
10. Rear Wheels
11. Front Wheel Drive + Parking Brake
12. Recovery Tank Cleanout Lid
13. Foam Float Ball & White Vac Filter
14. Hose Bracket- 15. Recovery Drain Hose
- 16. Tank Latch
- 17. Remote Solution Fill
- 18. Charger
- 19. Solution Sight Tube
- 20. Scrub Deck
- 21. Side Wipers
- 22. Squeegee Hose

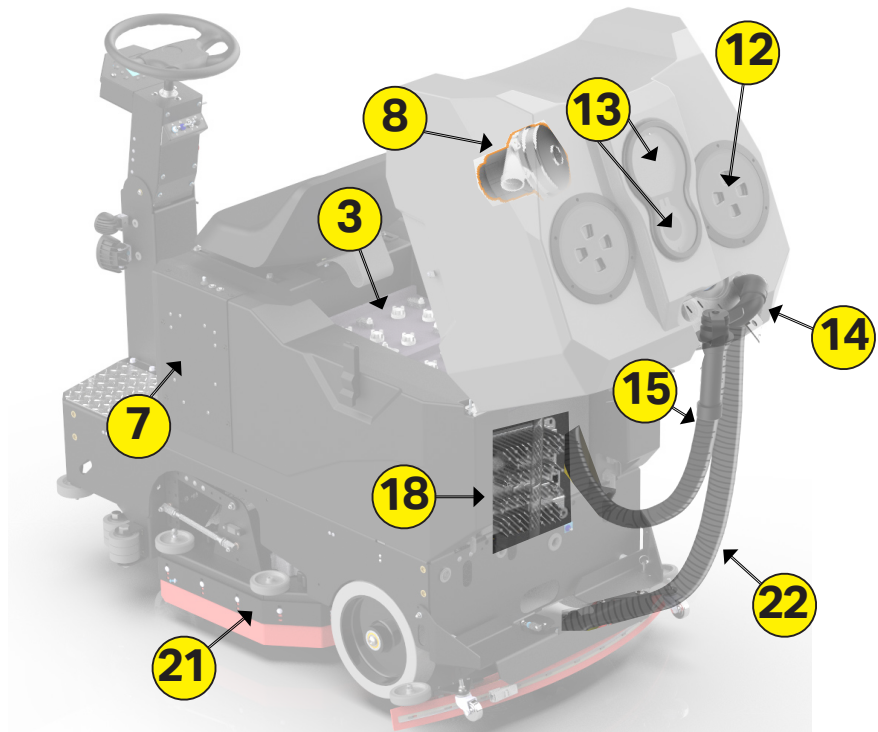
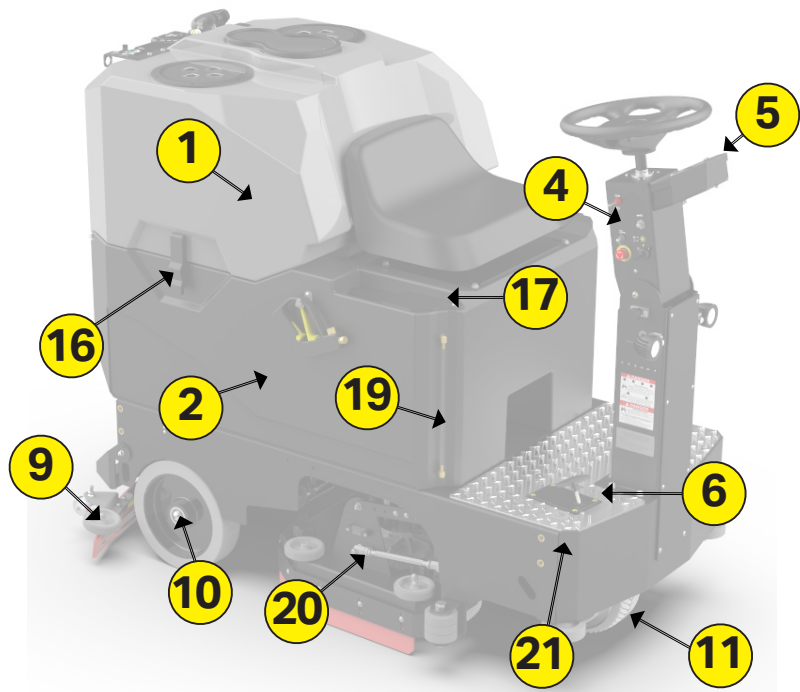

OPERATION

Central Command Overview

1. Full Recovery Tank Red Indicator
2. Empty Solution Tank Yellow Indicator
3. Vac Clog Indicator
4. Solution Flow Indicator
5. Down Pressure Setting
6. Vac Switch On-Off (ECON)
7. Solution/Deck/Vac Easy Button On-Off
8. Scrubdeck Switch On-Off (Pressure +/-)
9. 2 Sec symbol, hold for secondary operations
10. Technician View
11. Solution Flow Button
12. Reverse Switch (+BU Alarm)
13. Headlights
14. Horn
15. Key Switch On (I) / Off (O)
16. E-stop
17. Negative Busbar CB
18. Positive Busbar CB
19. Spray Gun Switch I/O

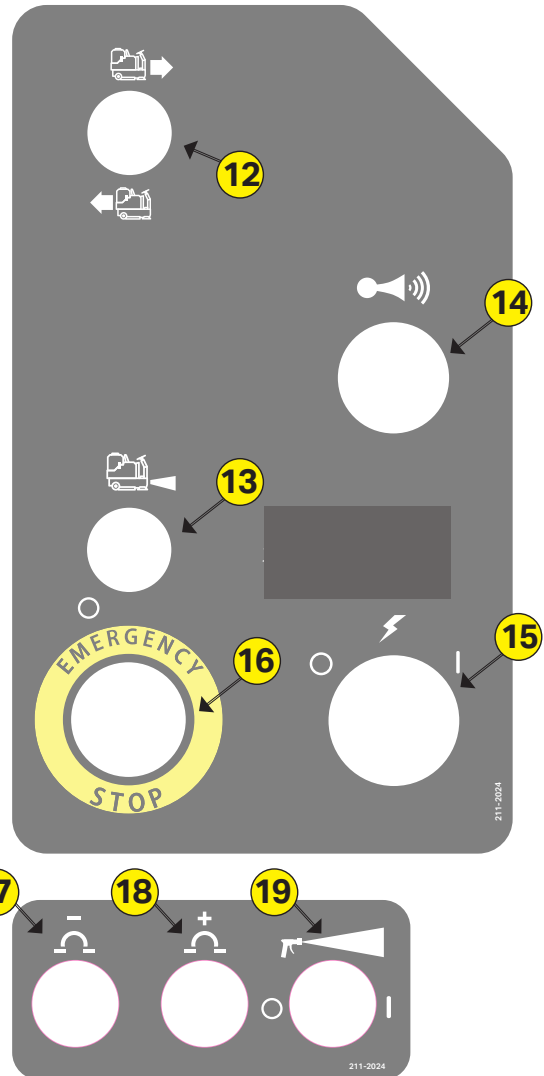
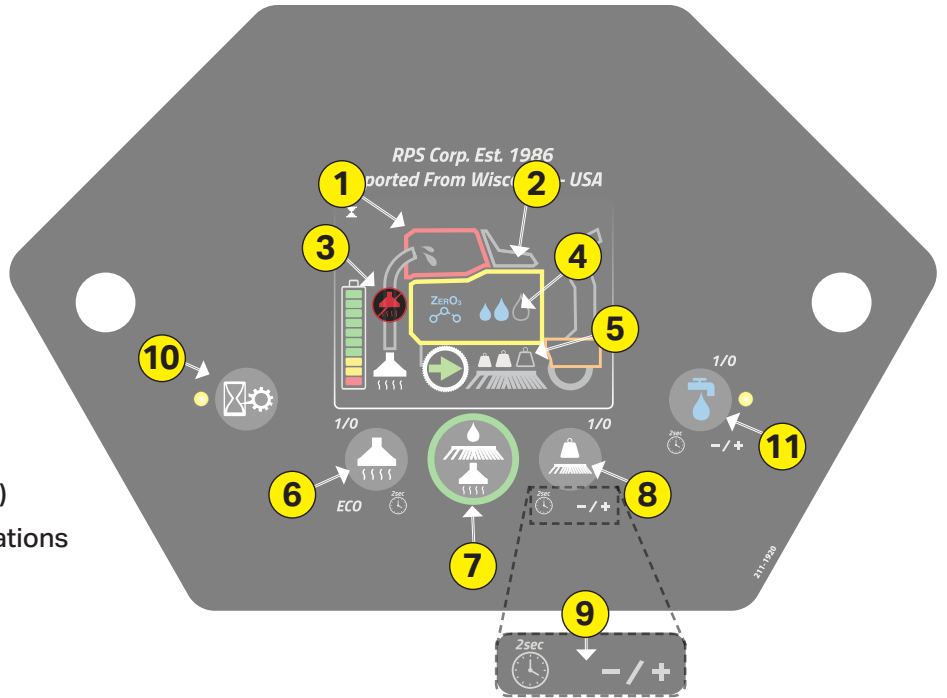

Touch Screen (Optional) (See pg 10.)

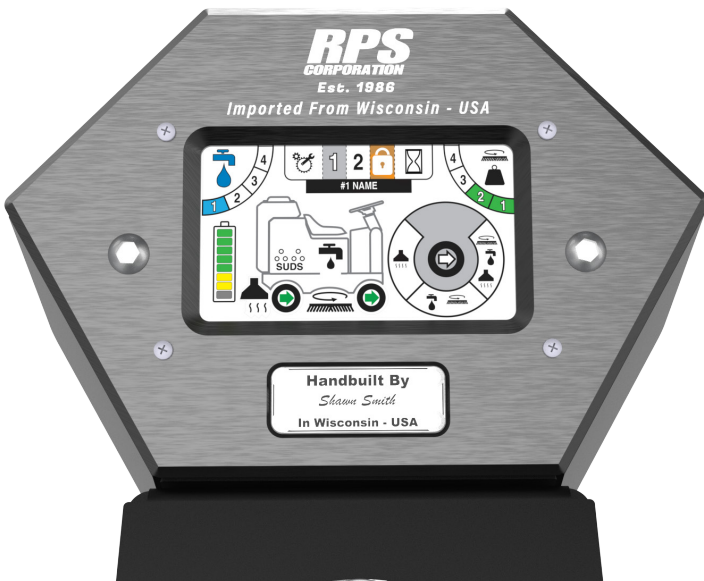

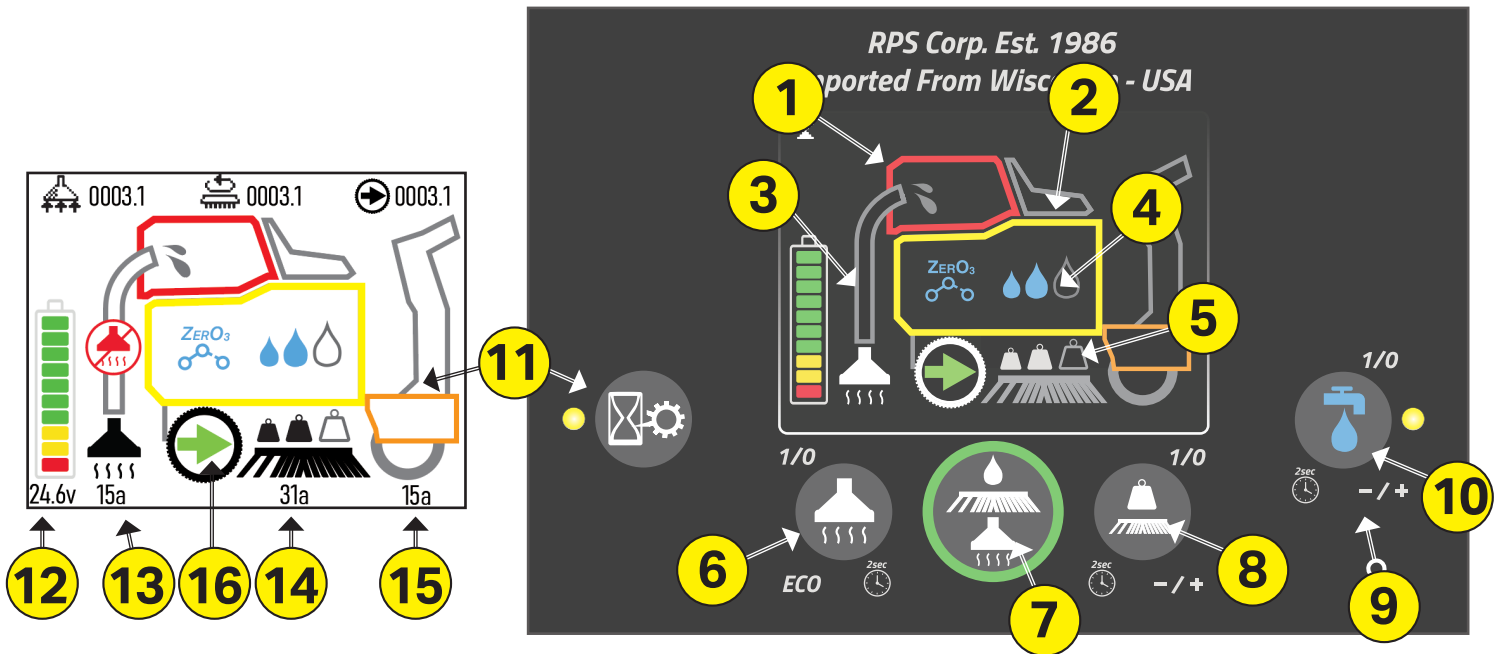
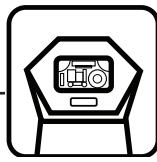

1. **FULL RECOVERY INDICATOR LIGHT** - The recovery tank flashes red Indicating when recovery is full and needs to be emptied.
2. **EMPTY SOLUTION INDICATOR LIGHT** - The solution tank flashes yellow Indicating when the solution tank is empty.
3. **VAC CLOG INDICATOR** - When the vac is clogged it will be indicated on the screen
4. **SOLUTION LEVEL** - Shows the selected level of water (Off, 1, 2 , 3)
5. **DECK DOWN PRESSURE LEVEL** - Shows the selected level of deck down pressure (Off, 1, 2 , 3)
6. **VAC** - Push on/off. Hold 2 seconds to engage ECO mode.
7. **SOLUTION/DECK/VAC EASY BUTTON** - Engage all scrubbing operations with one button, solution/deck/vac with one button.
8. **DECK/DOWN PRESSURE** - Push on/off to engage deck. Hold for 2 seconds to select level of deck down pressure (Off, , 2, 3)
9. **SECONDARY FUNCTIONS INDICATOR** - The 2 sec hold function unlocks secondary functions wherever listed.
10. **SOLUTION BUTTON** - Push on/off to engage solution. Hold for 2 seconds to select level of solution to the deck (off. 1, 2, 3)
11. **TECHNICIAN SCREEN** - Turns on voltages and amp draw, reverses screen colors to white.
12. **ACTIVE VOLT & AMP DRAW** - Indicates the live DC Volts (under battery gauge) and Amp draw (under systems) when machine is running. Lithium SOC (State Of Charge) %.
13. **AMP VAC CURRENT** - Indicates Vac power consumption
14. **BRUSH DISK CURRENT** - Indicates Brush power consumption
15. **TRANSPORT AMP** - Indicates Drive power consumption
16. **TRANSPORTATION** - Green Arrow forward / Red Arrow Reverse.

OPERATION

Touch Screen Operation (Optional)

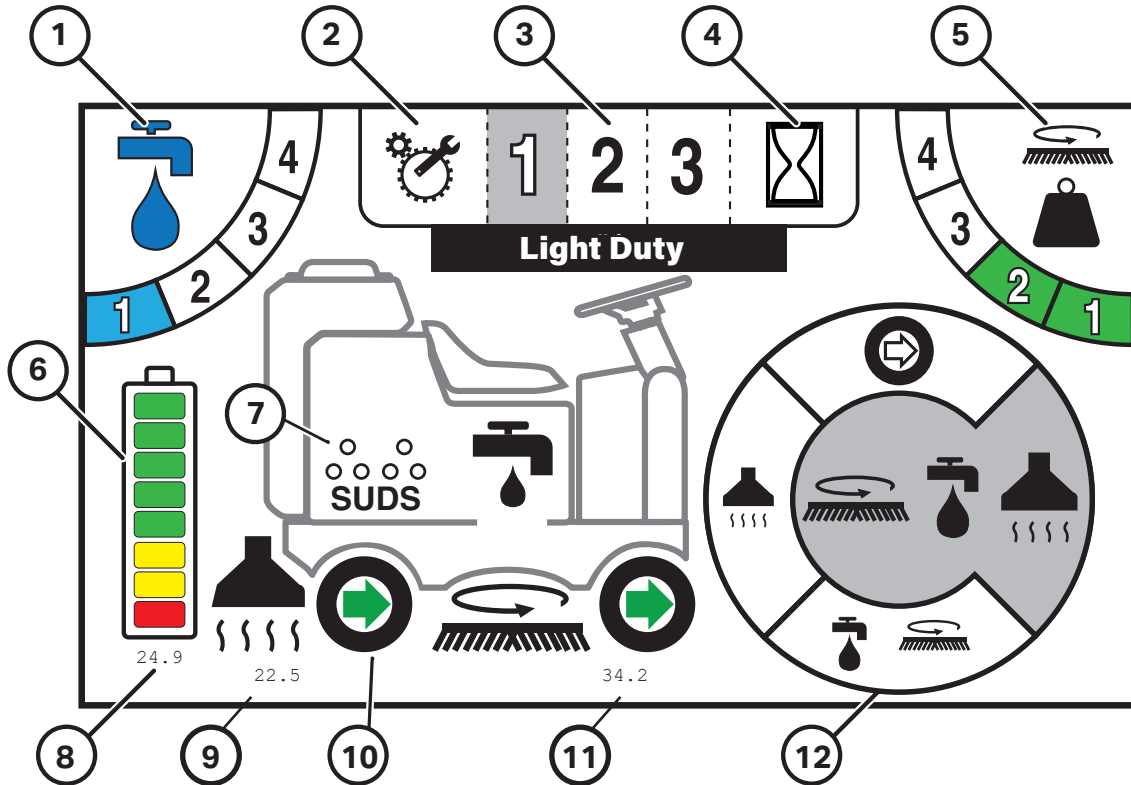
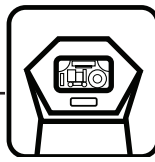

1. **SOLUTION OUTPUT** - Indicates the level of solution that is being dispensed when in operation, (0 = off, 1 = Low, 4 = High).
2. **TECHNICAL / MANAGER SETUP** - Access 'Error Code History' and Manager Programming
3. **PROGRAMMED ZONES** - Switch between preset solution and downpressure settings for varying applications
4. **HOUR METERS** - Displays all of the hour meters of the machine: Key Switch, Transport, Scrub Motors, and Vacuum Motor
5. **DOWN PRESSURE OUTPUT** - Indicates the level of downpressure that is being applied to the floor surface (1 = low, 4 = high).
6. **BATTERY GAUGE** - Indicates the level of battery charge available and volt meter
7. **SUDS** - (Onboard Chemical Dilution) indicator
8. **ACTIVE VOLT & AMP DRAW** - Indicates the live DC Volts (under battery gauge) and Amp draw (under systems) when machine is running
9. **AMP VAC CURRENT** - Indicates Vac power consumption
10. **TRANSPORT INDICATION** - Green Forward & Red Rev
11. **BRUSH DISK CURRENT** - Indicates Brush power consumption
12. **OPERATION MODE SELECTOR** - Cycle through and select which operation mode you would like to work in

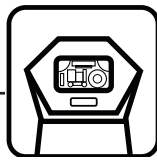

Touch Screen Operation (Optional)

Mode Selection

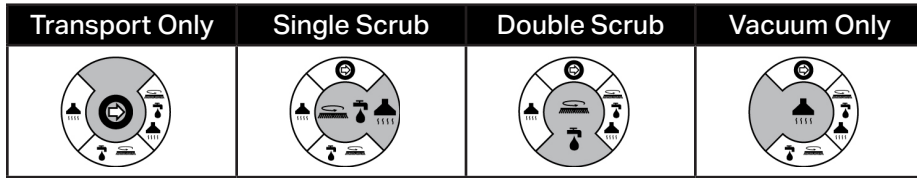

Solution Setting

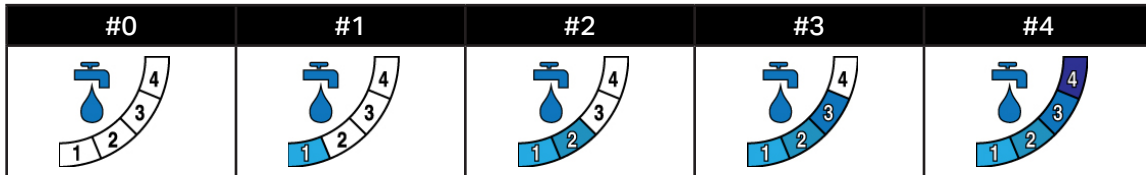

Down Pressure Setting

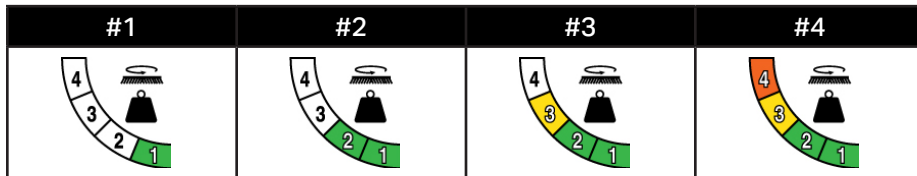

Forward Transport Motor

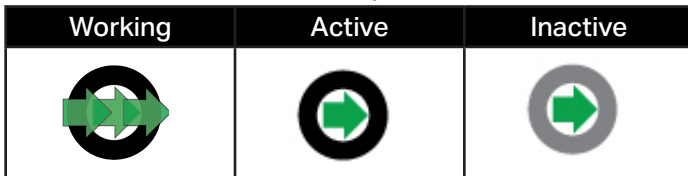

Reverse Transport Motor



Solution Flow



Vacuum Motor

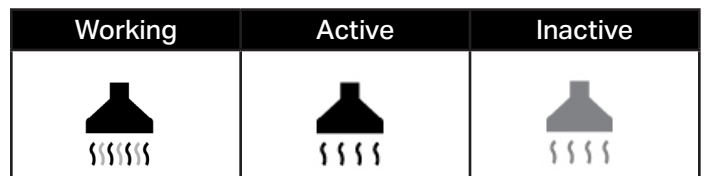

Scrub Deck Motor(s)

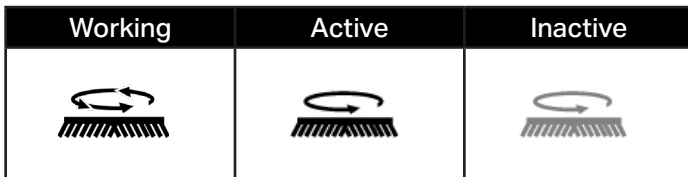

Scrub Deck Motor(s)



Setup



Hour Meters



OPERATION

Touch Screen Operation (Optional)

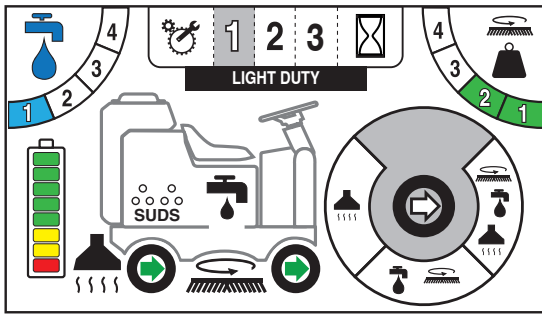
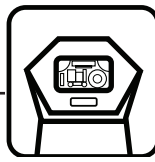

The touch screen is designed to be programmed to three specific zones. Each zone can be named and custom programmed or even disabled if not needed.

The zone you are working in is highlighted as indication. In Figure 1. the zone selected is Light Duty.

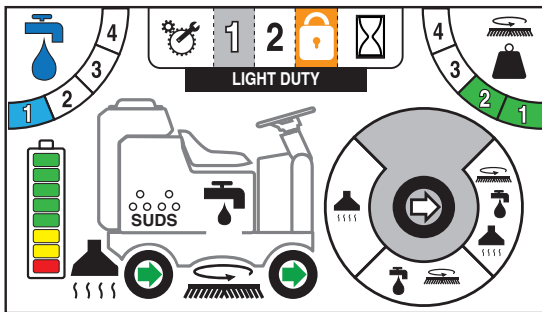

Figure 2. shows Zone 3 "locked out" by the indicator lock icon.

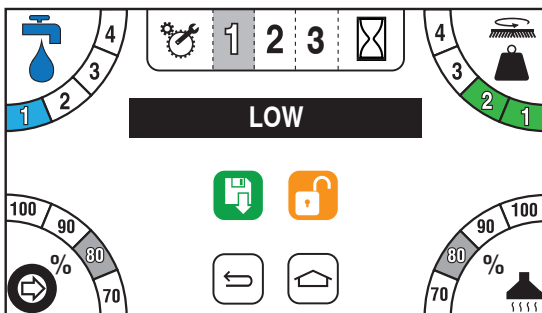

Figure 3. shows Zone 1 "Light Duty" Factory Configuration.

Water = 1
Downpressure = 2
Drive Speed = 70%
Vac Motor = 80%

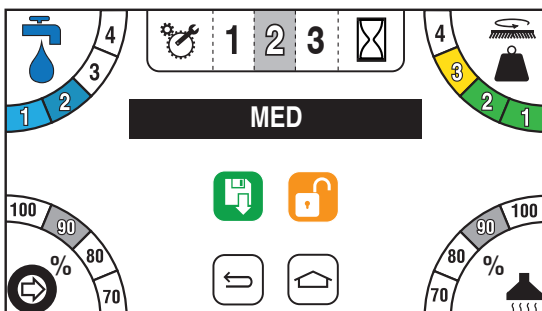

Figure 3. shows Zone 2 "Daily" Factory Configuration.

Water = 2
Downpressure = 3
Drive Speed = 90%
Vac Motor = 90%

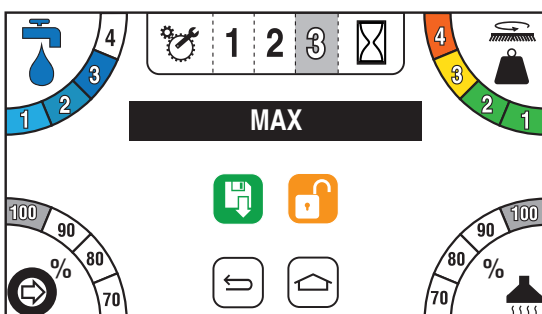
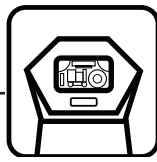
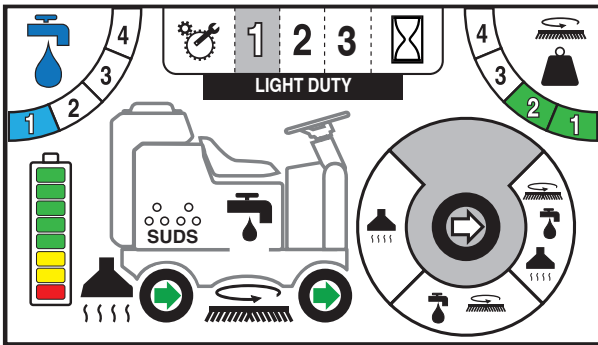

Figure 3. shows Zone 3 "Heavy Duty" Factory Configuration.

Water = 3
Downpressure = 4
Drive Speed = 100%
Vac Motor = 100%



Touch Screen Operation (Optional)



To program the 3 Zones, press

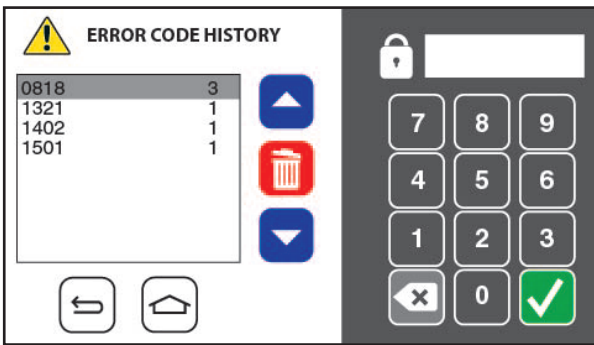

From here you will be prompted with a passcode screen. Enter the manager passcode 349 to get access to setup.



Once you have entered the password, you will see the Figure 3. screen where you can alter the name, solution output, down-pressure setting, scrubbing speed, and vacuum power.

Alternatively you can lock the Zone out from this screen, to prohibit operator use.

Once any of the 3 "Zones" is locked the remaining zones are no longer adjustable either by the operator.



To alter the name of a Zone, simply click on the black name box and a full keyboard will appear as Figure 4. shows. Enter new name and save your work with the Green save .

OPERATION

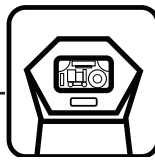

Membrane Icons

BATTERY



10% Increment drops until battery dead

DOWN PRESSURE



VAC

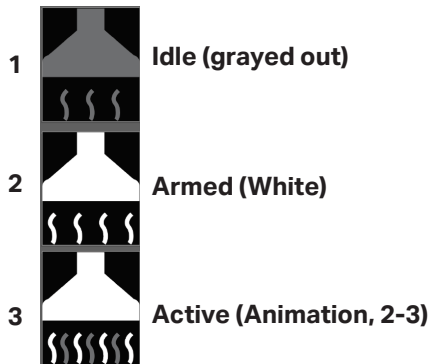

BRUSH

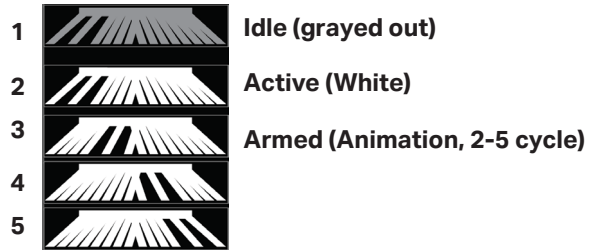

WATER

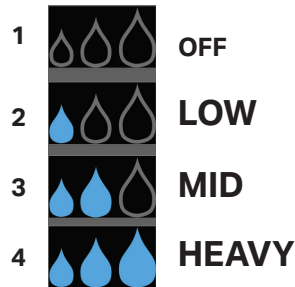

VAC ECO

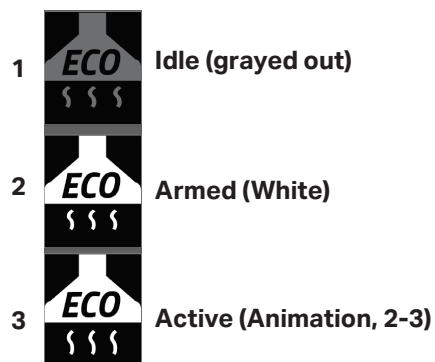

SETTINGS SCREEN

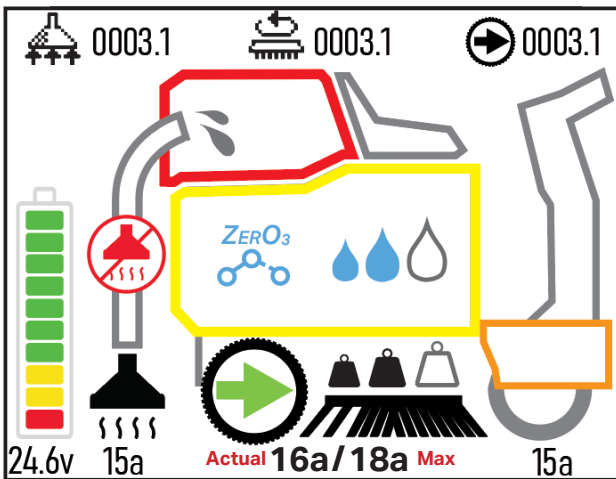

Background changes to white, hour meter icons at top of screen showing vac, brush, and traction hour meters.

TRACTION REVERSE

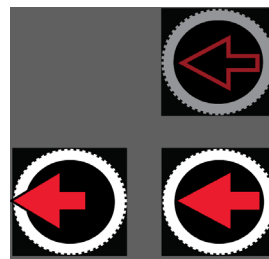

1
ACTIVE
1-2 CY-

TRACTION FORWARD

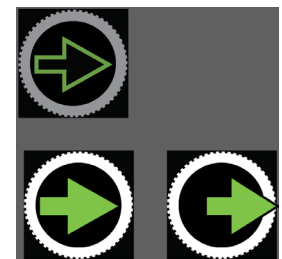

2
1
ACTIVE
1-2 CY-



! WARNING

Do not park this machine on ramps or slopes.
Always park this machine on a level, hard surface.
Do not operate this machine outdoors or on uneven surfaces.

! WARNING

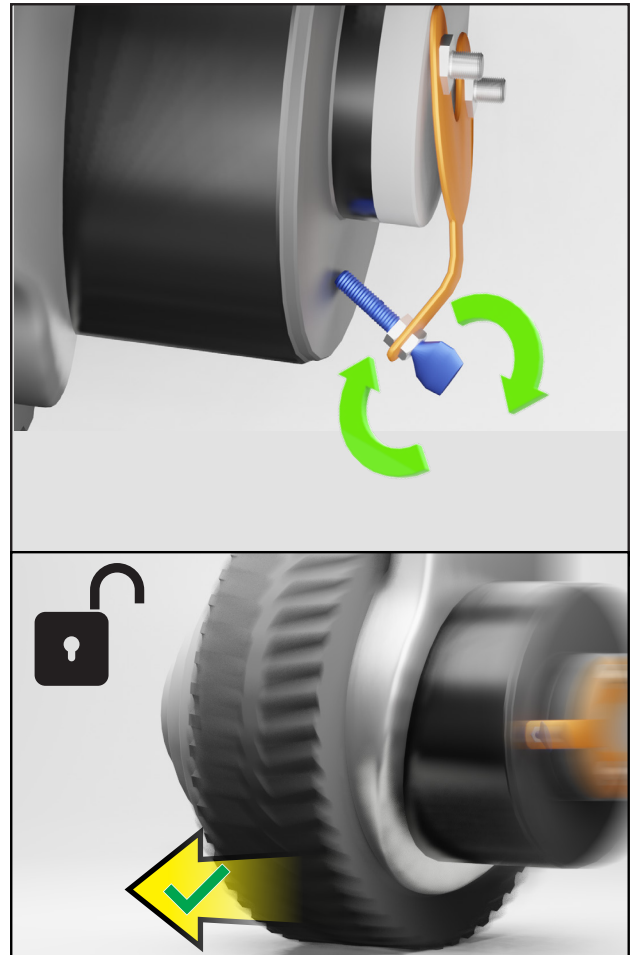
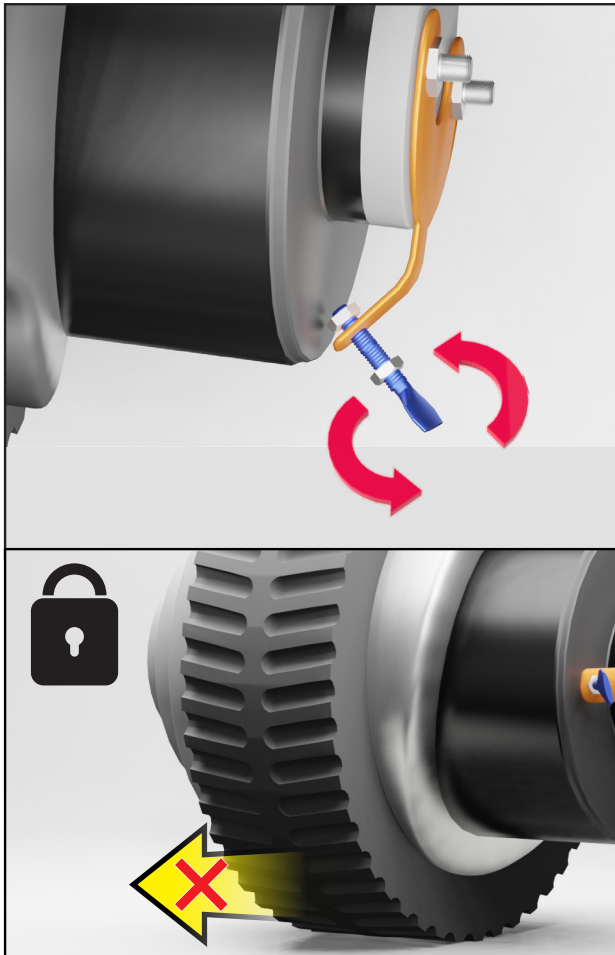
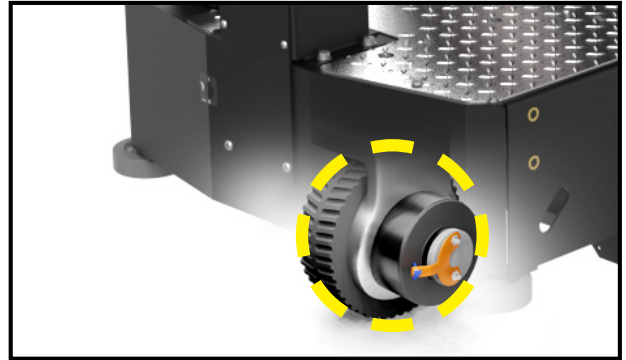

Understand the dynamic braking system before you operate the machine on ramps. Machine may coast.

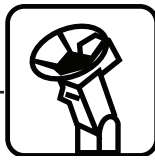

OPERATION

Steering Controls



1. 	2. 	3.  EMERGENCY STOP
--	--	--



Headlights (Optional)

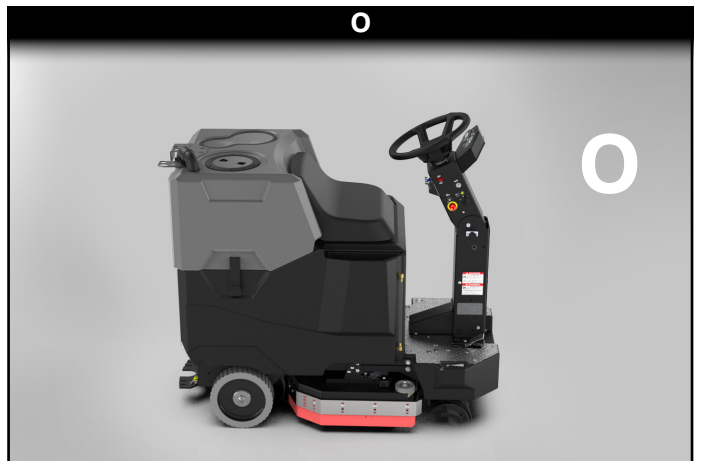

OPERATION

Spray Jet Controls (Optional)

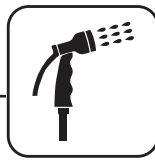

Solution Tank

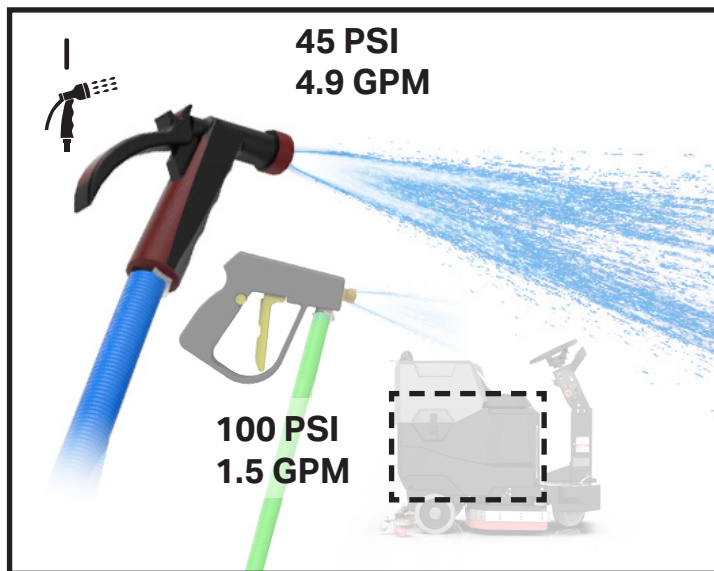

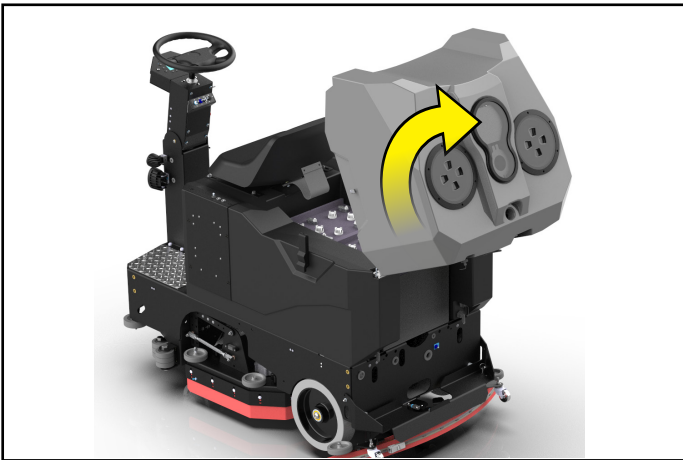
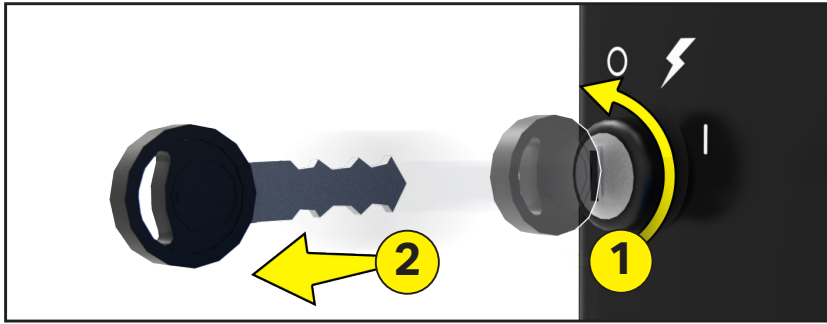
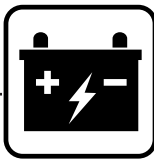

NOTICE

Batteries are a possible environmental hazard. Consult your Battery supplier for safe disposal methods.

WARNING

Before you service a Battery, always wear face protection, protective gloves and protective clothing. Battery acid or battery explosion can cause serious injuries.



WARNING

The Batteries in this machine contain sulfuric acid, which causes burns to skin. If battery acid contacts clothing or skin, rinse the effected area with cold water immediately. If battery acid gets on your face or in your eyes, flush the area immediately with cold water and seek medical attention.

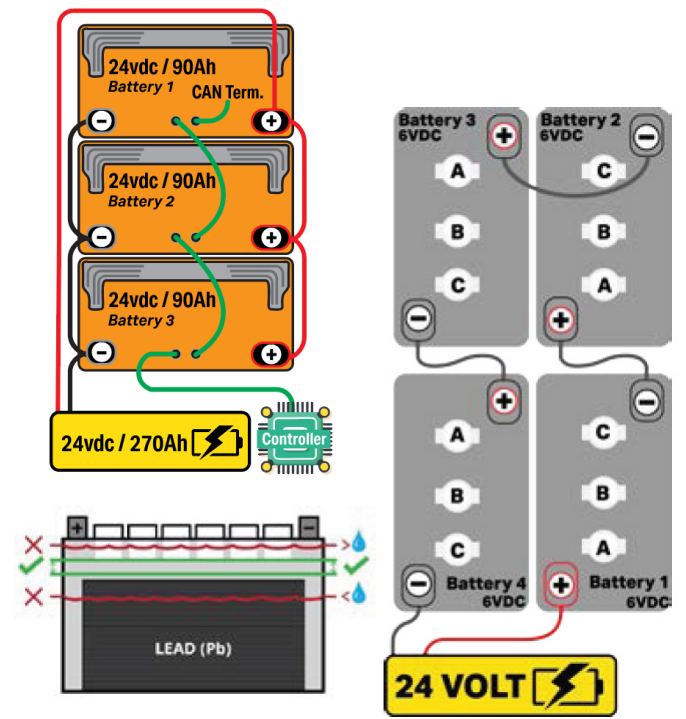

Torque Settings:
8-12 ft/lbs (10.8 - 16.3 Newton-meters)

OPERATION

Squeegee Installation

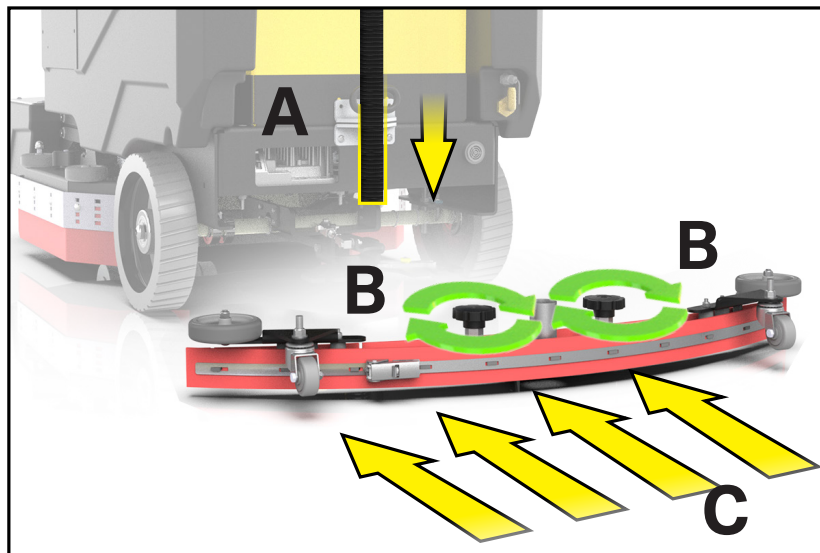
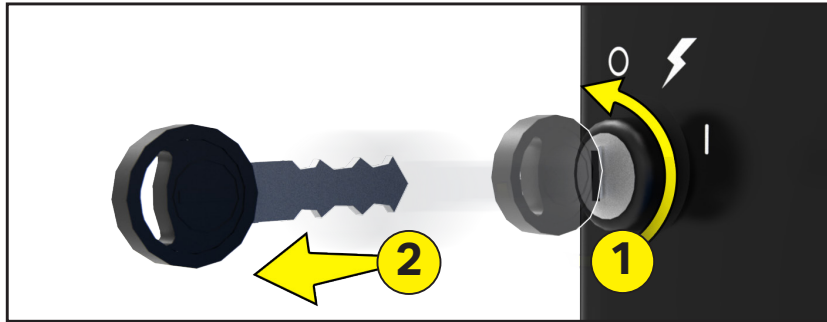
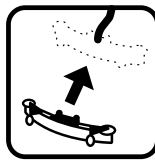



OPERATION

Squeegee Adjustment

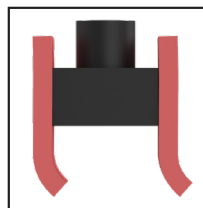
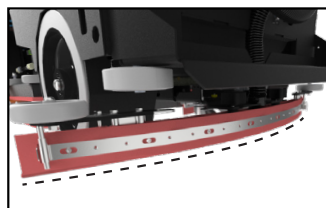
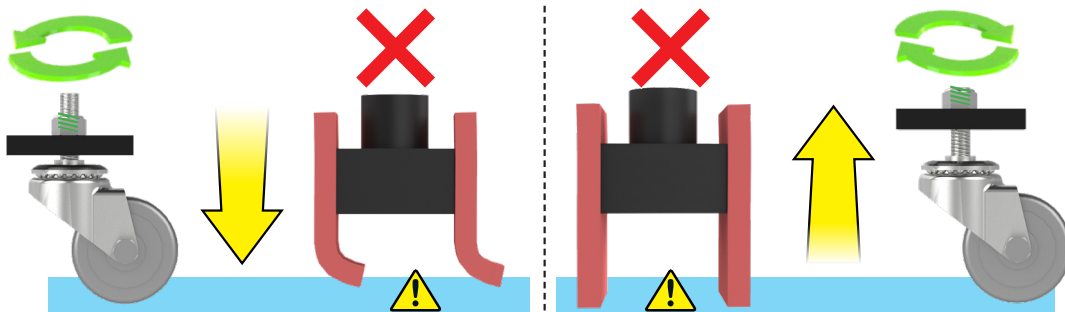
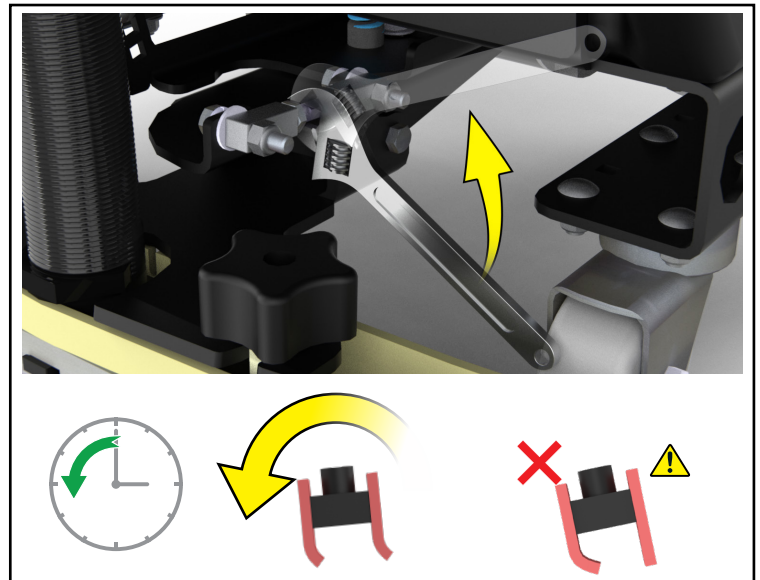
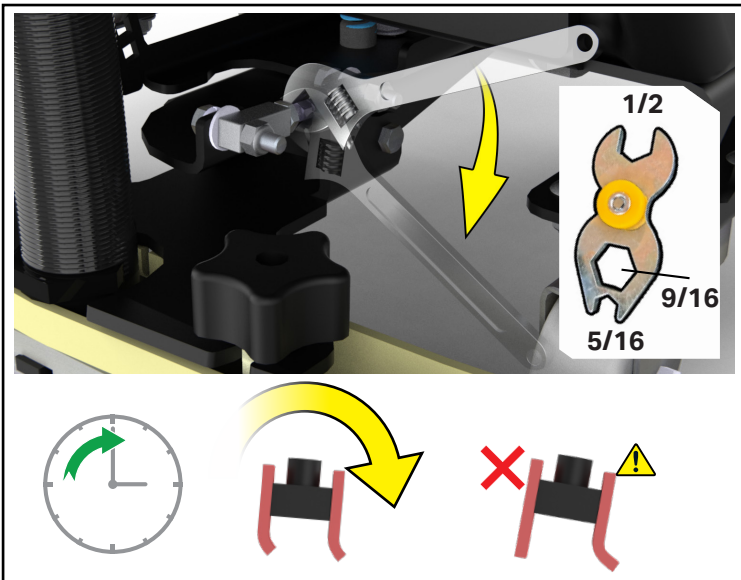
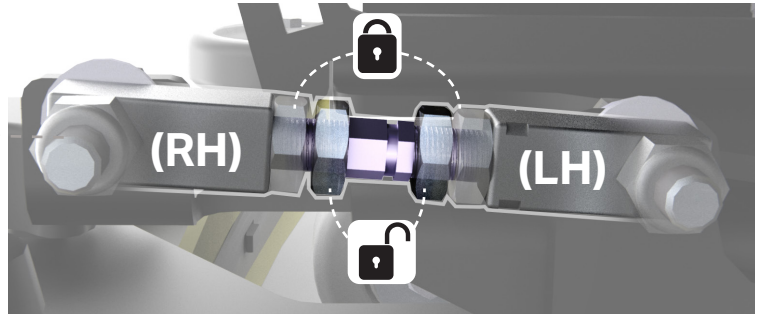
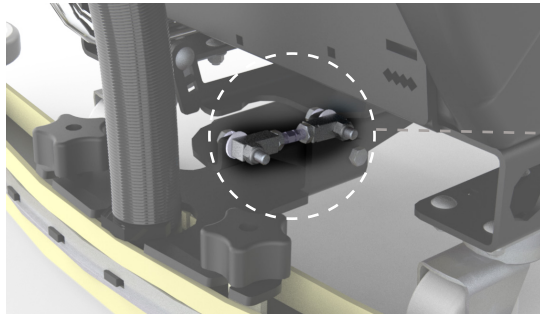
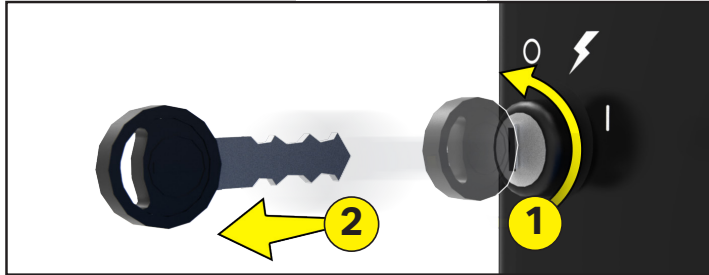

OPERATION

Forward Drive

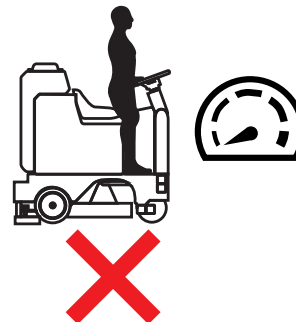
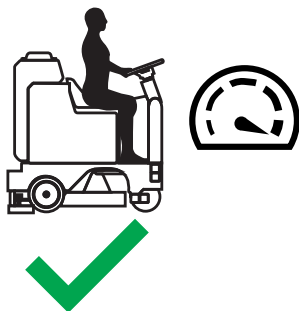
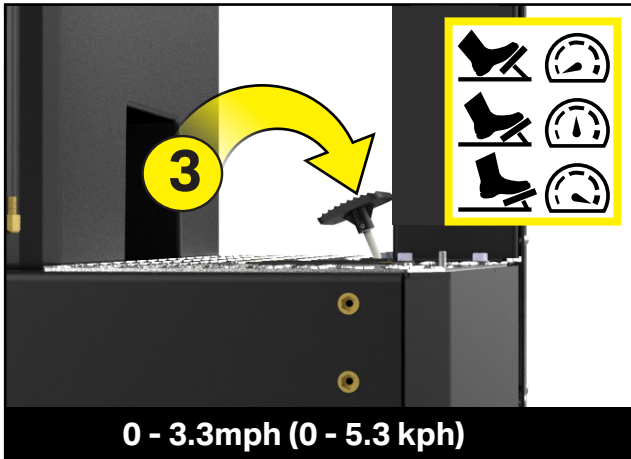
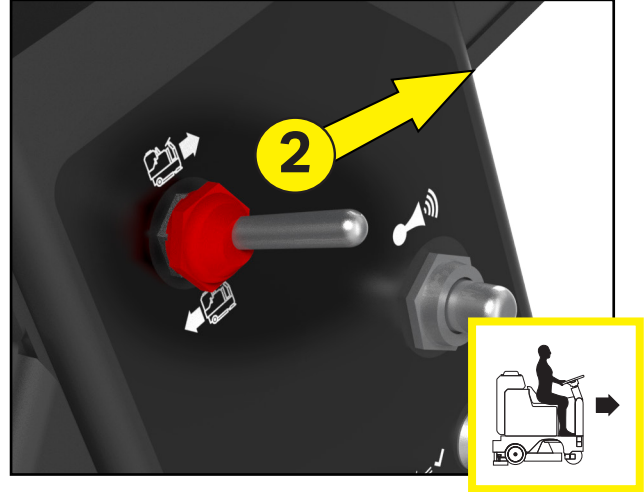
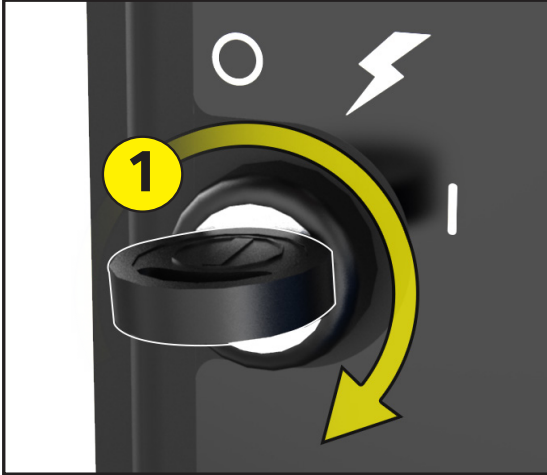



OPERATION
Reverse Drive

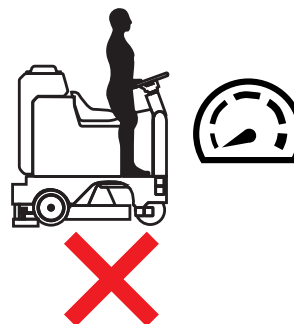
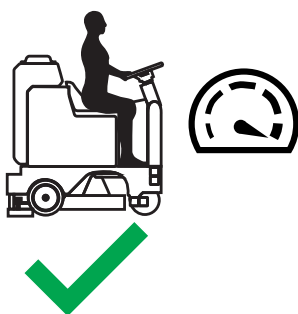
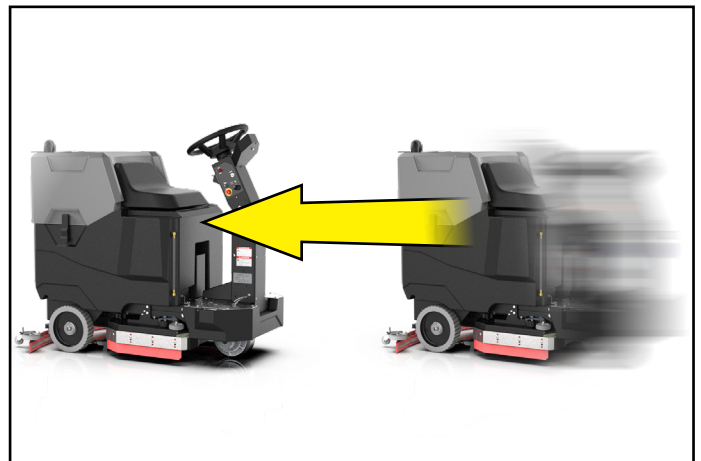
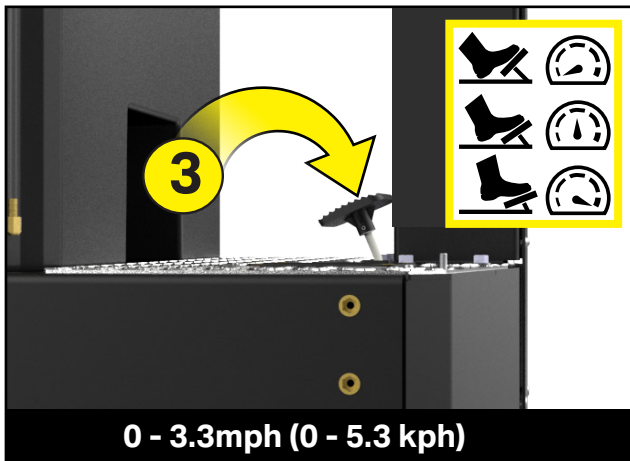
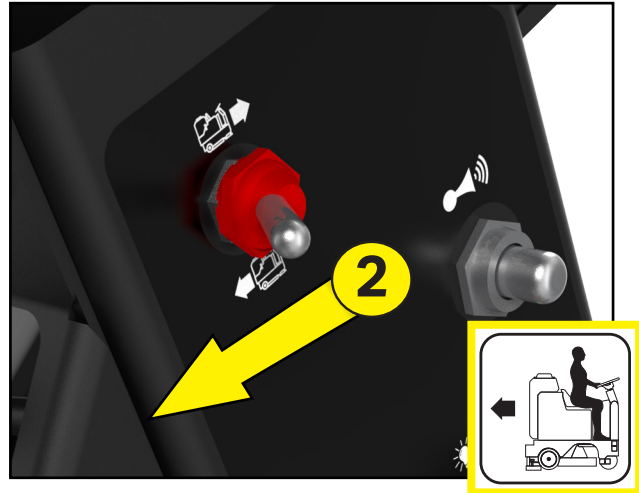
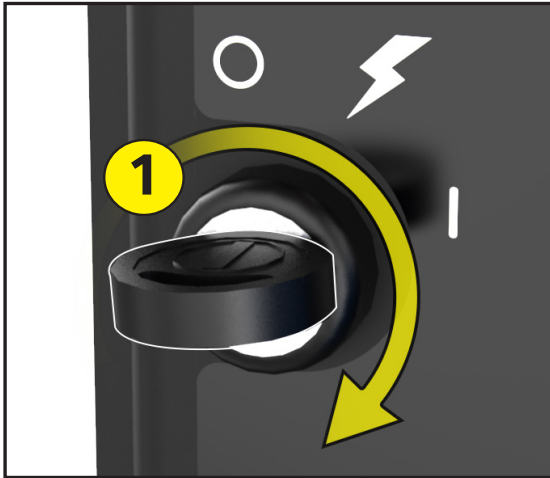

OPERATION

Fill Solution Tank

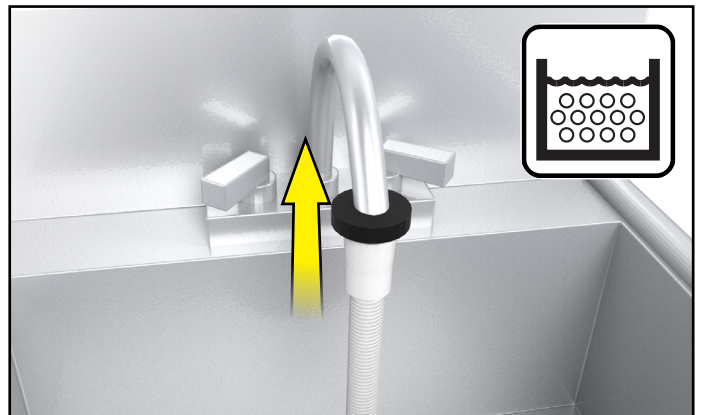
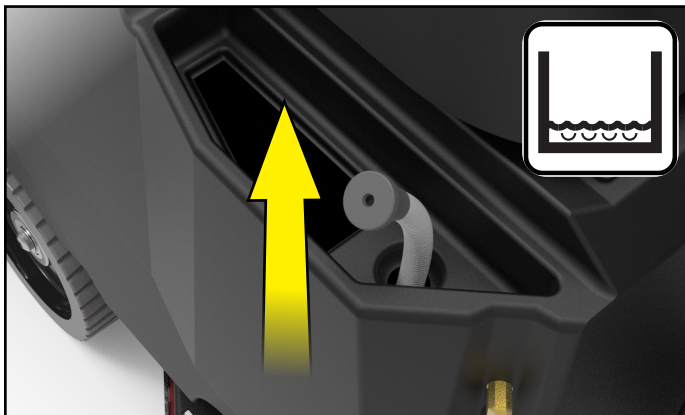
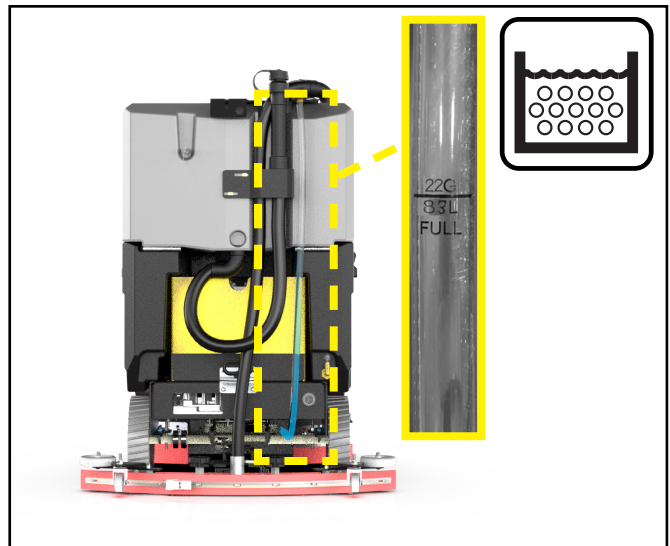
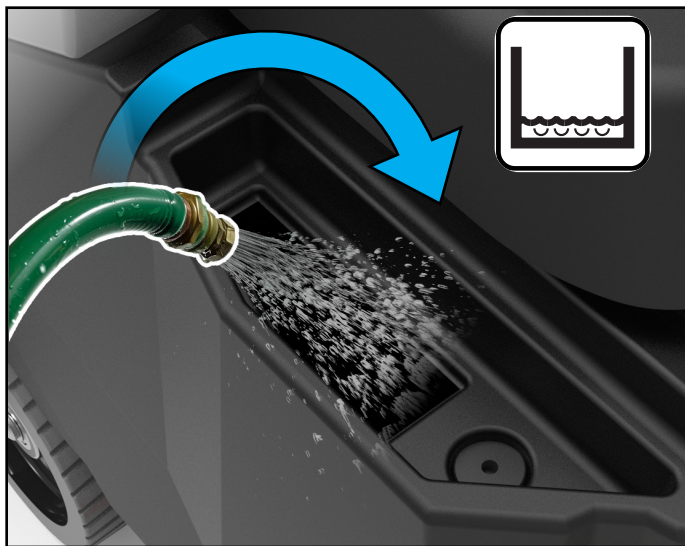
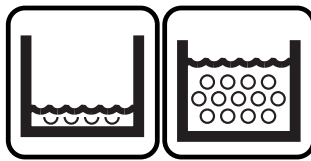

! DANGER

EXPLOSION RISK!
FLAMMABLE MATERIALS CAN CAUSE AN EXPLOSION OR FIRE. DO NOT USE FLAMMABLE MATERIALS IN TANK OR PICK UP.

TO AVOID DAMAGE TO THIS MACHINE:

- USE APPROVED DETERGENTS ONLY
- WATER TEMPERATURE MUST NOT EXCEED 130°F/54°C
- DO NOT USE HIGH-PERCENTAGE BLEACH MIXTURE

REFER TO MANUAL OR CALL +011-262-681-3583

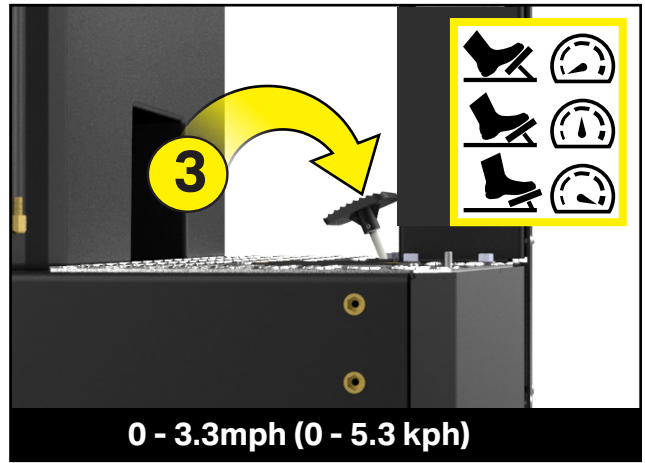
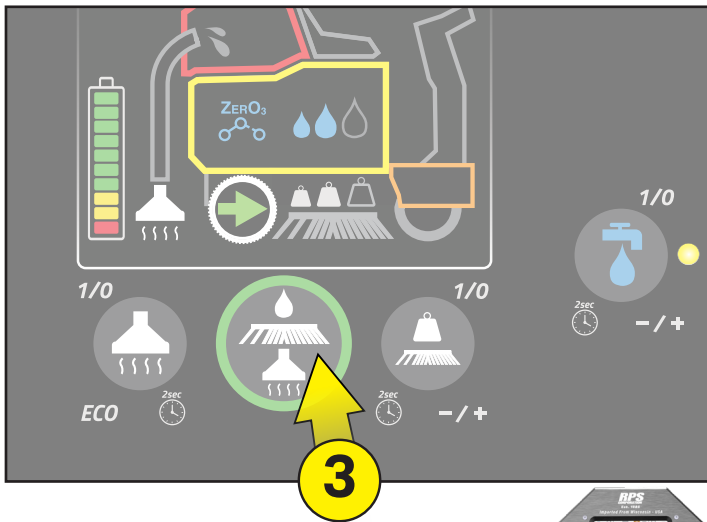
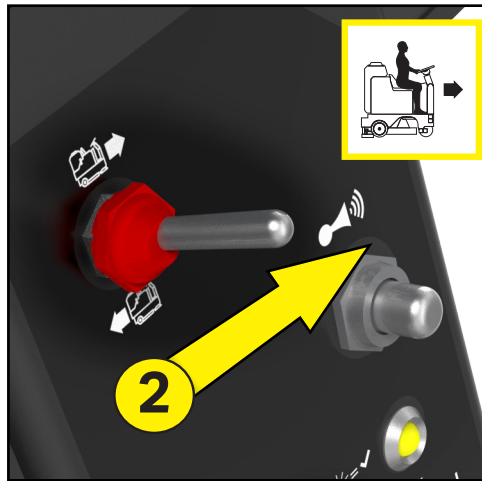
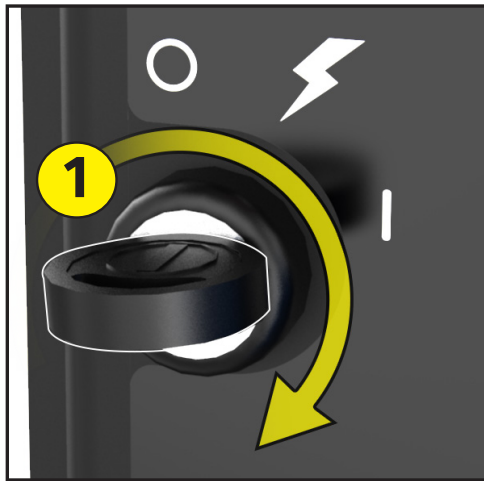

See page 8 for Touch Screen Controls

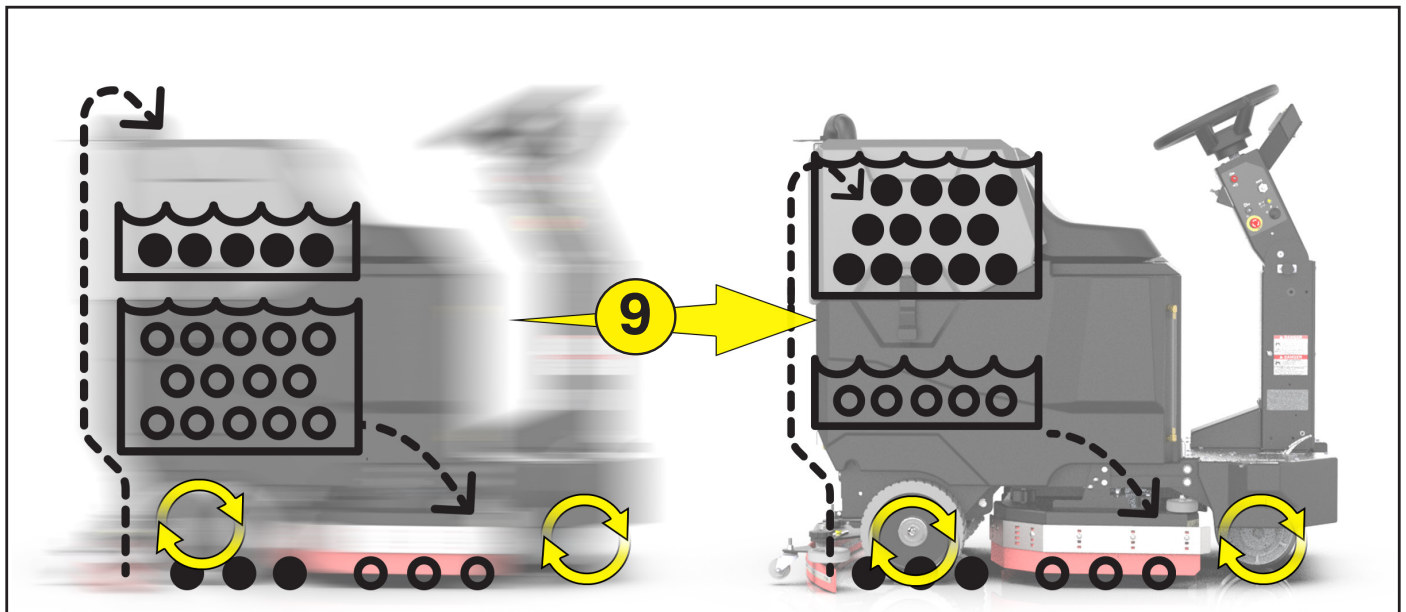

OPERATION



Drying

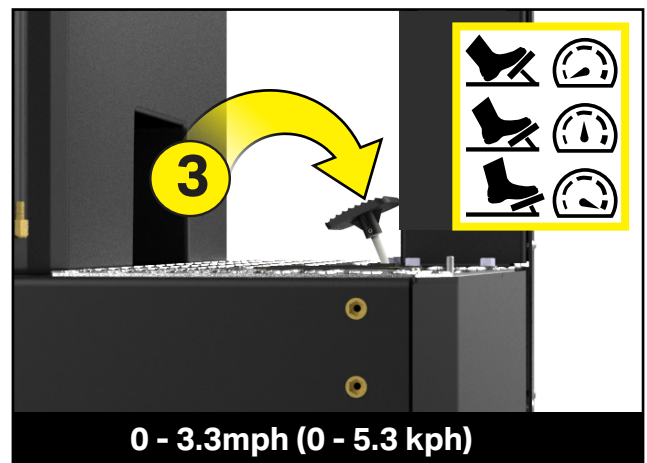
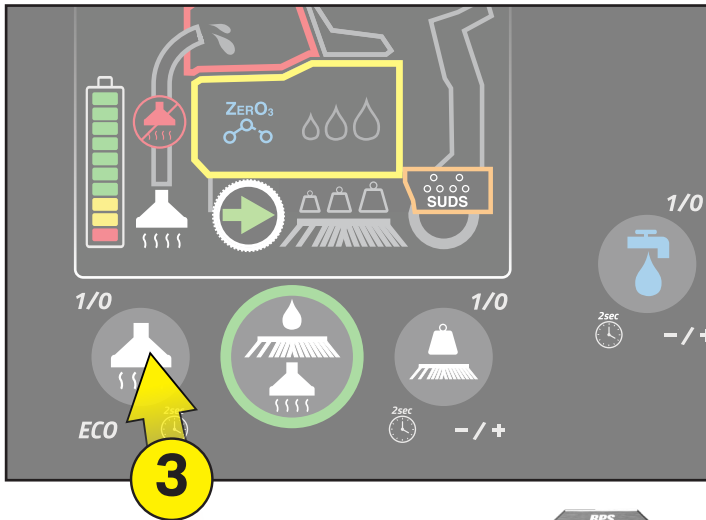
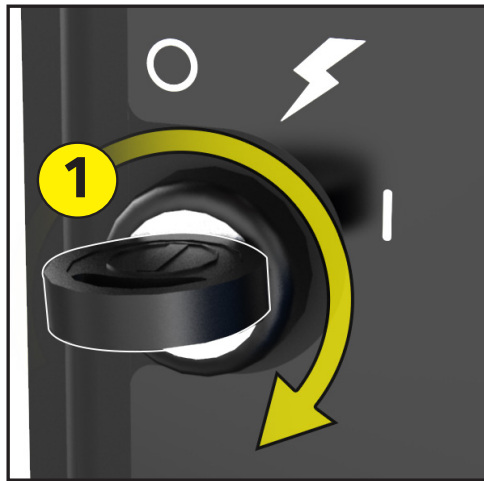

See page 8 for Touch Screen Controls

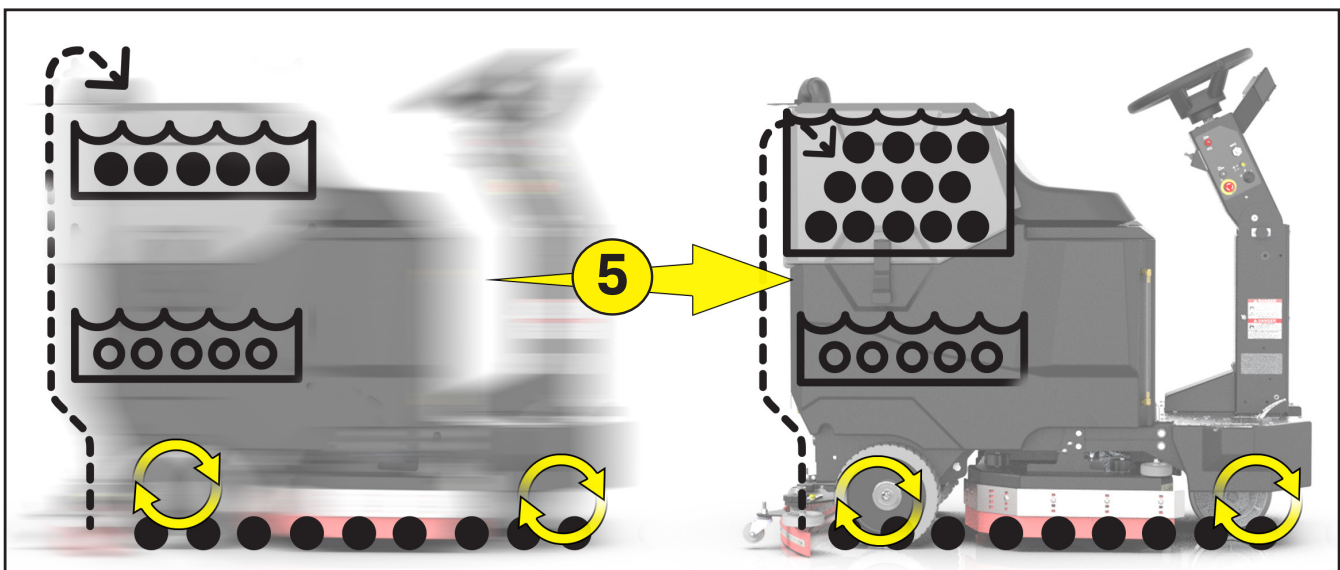

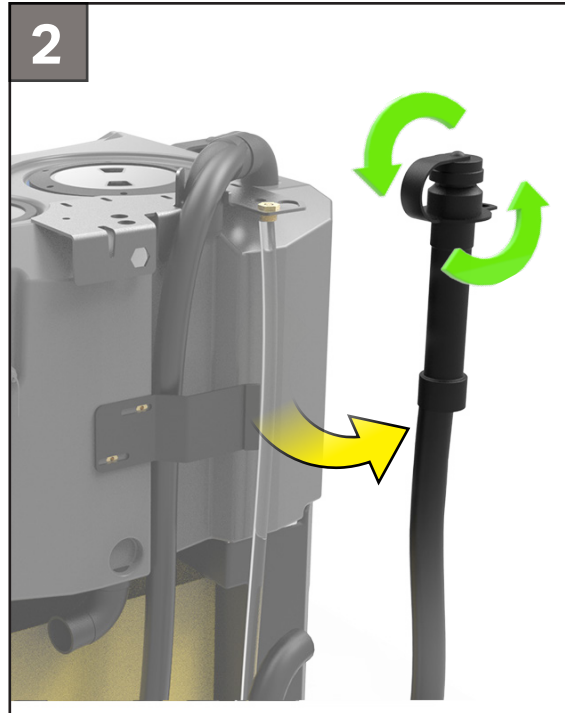

OPERATION



Flushing Recovery Tank

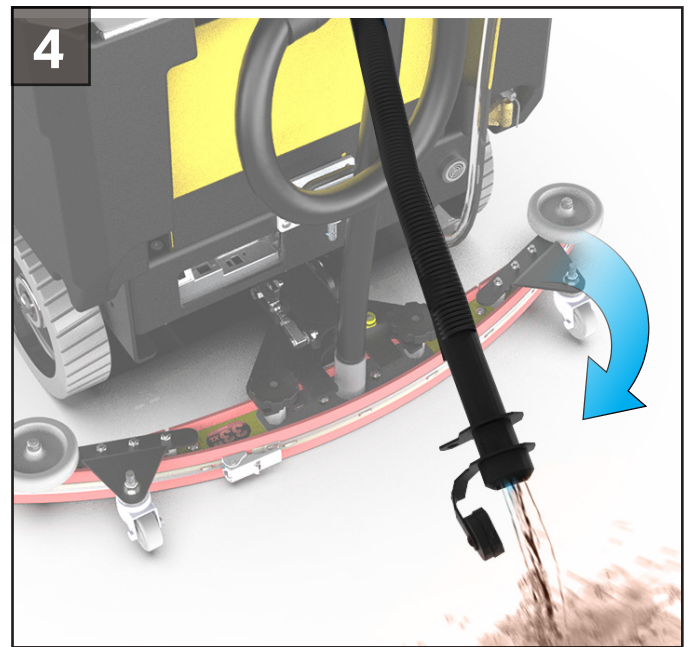
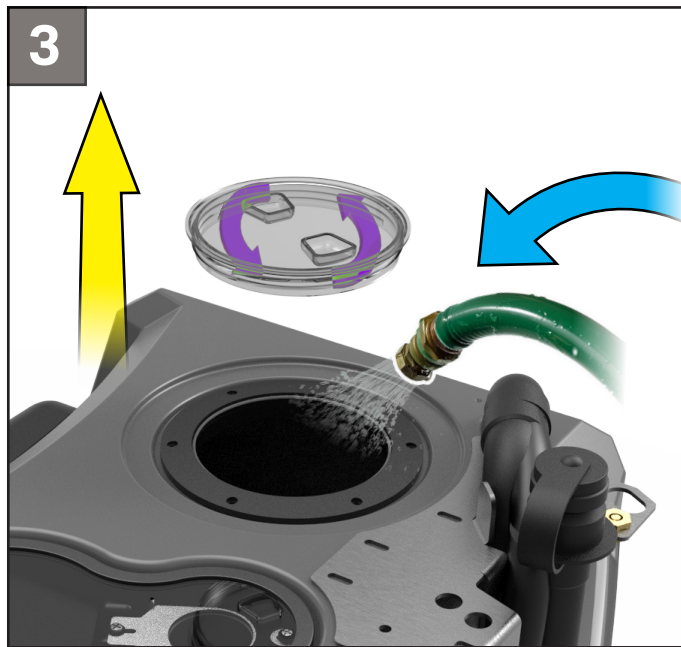
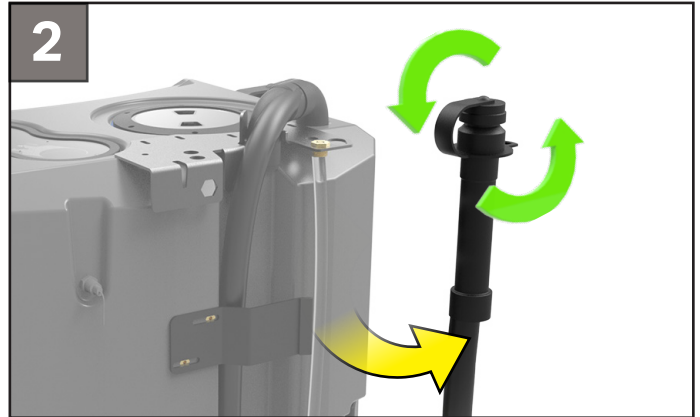

NOTICE

Drain "clean" Solution & "dirty" Recovery solution into APPROVED drains

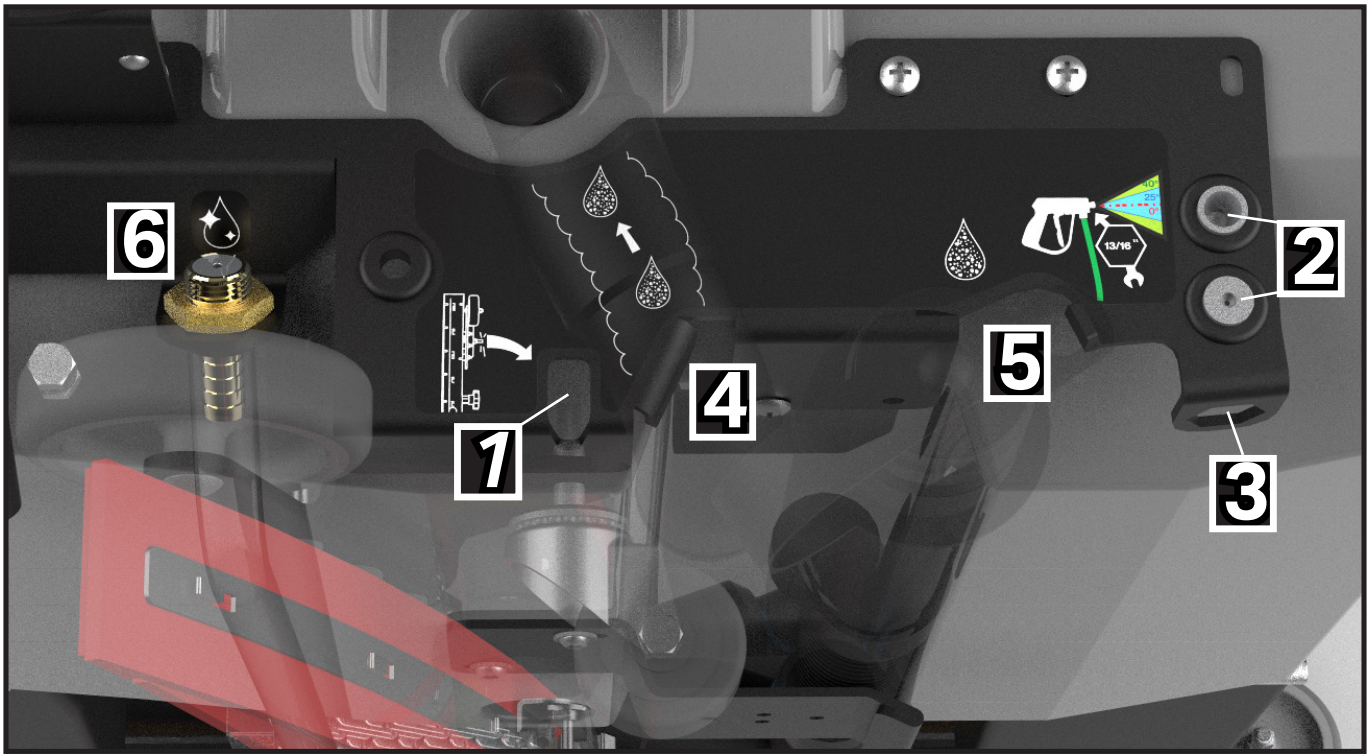
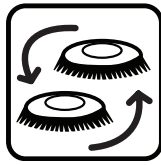

1. Squeegee Hang Bracket
2. Spare Nozzle Tips
3. Nozzle 13/16" Wrench For Spray Gun Tips
4. Squeegee Hose Guide
5. Recovery Drain Hose Hang Post
6. Clean Solution Drain Hose

DAILY MAINTENANCE

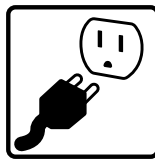

Charge Batteries

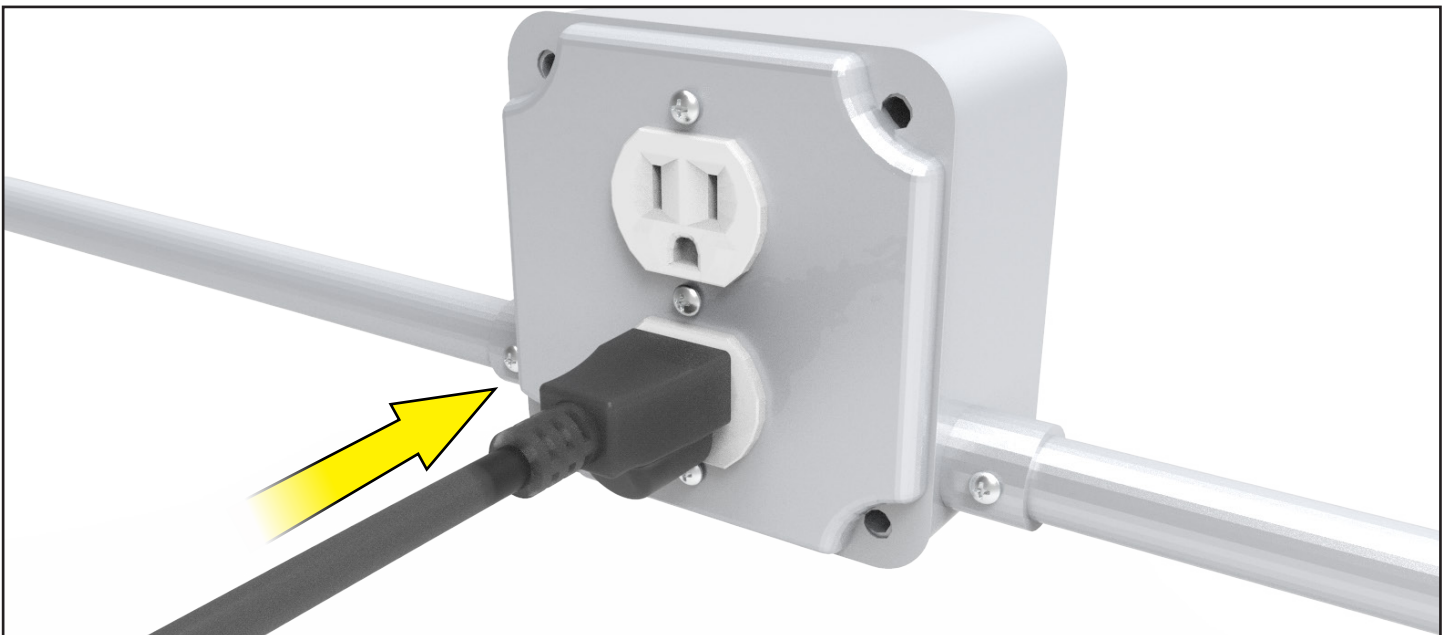
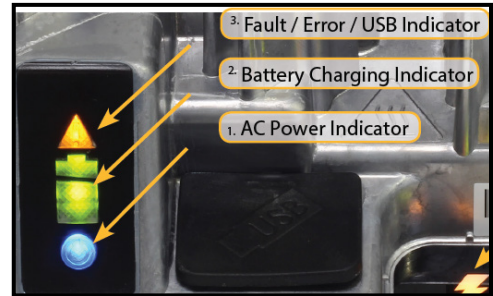
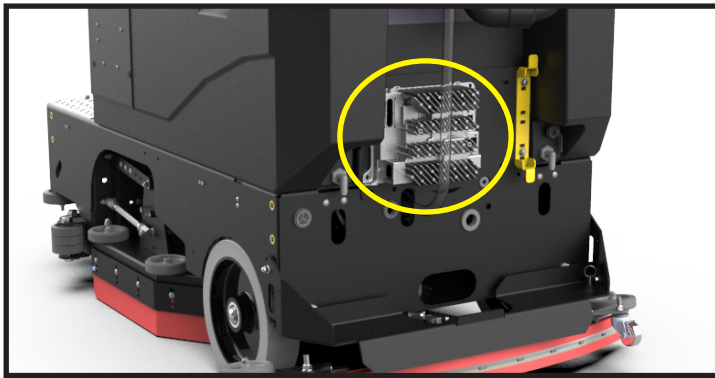
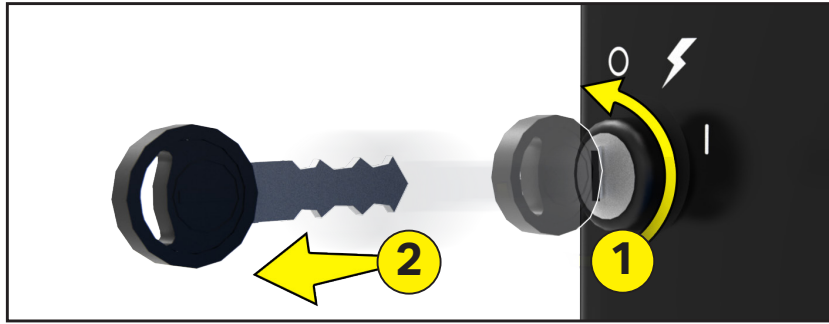

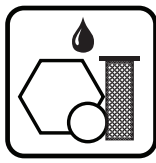

WEEKLY MAINTENANCE (OR 25 HRS)

Clean White Filter/Screen

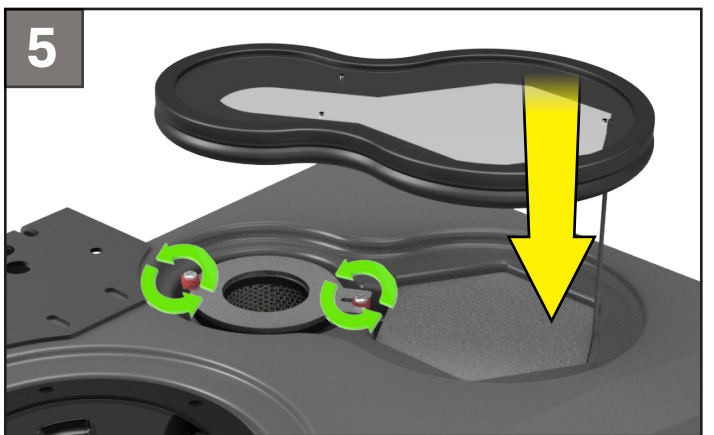
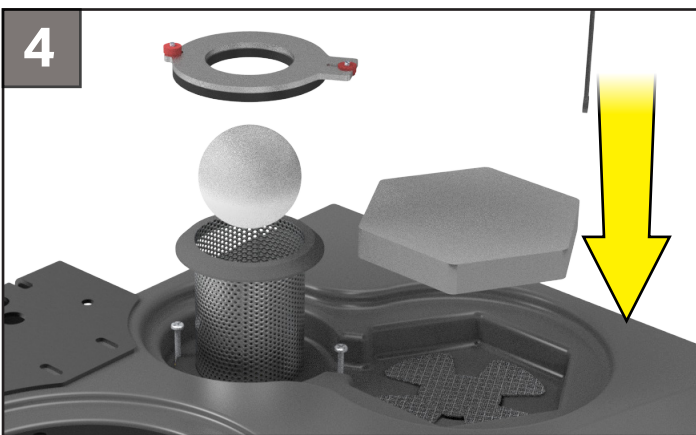
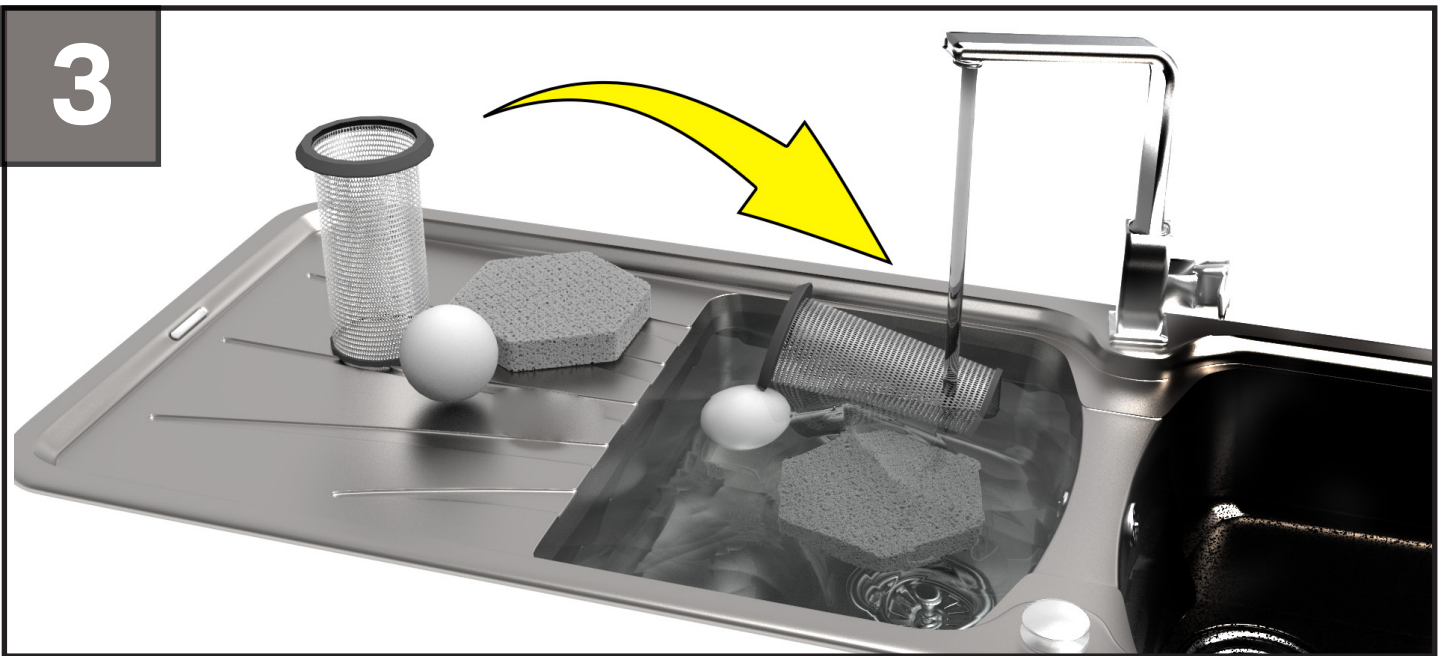
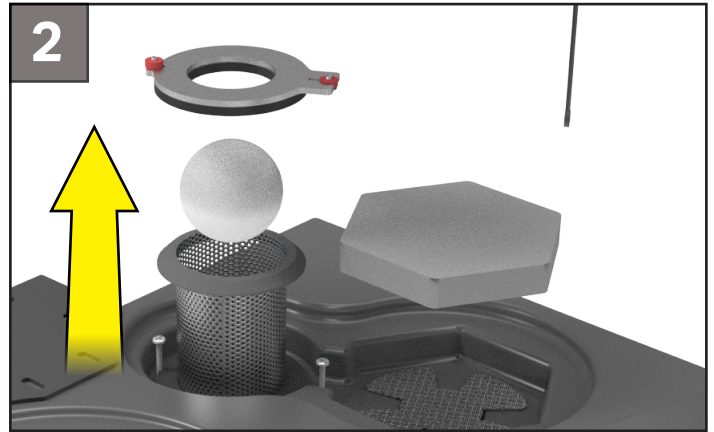
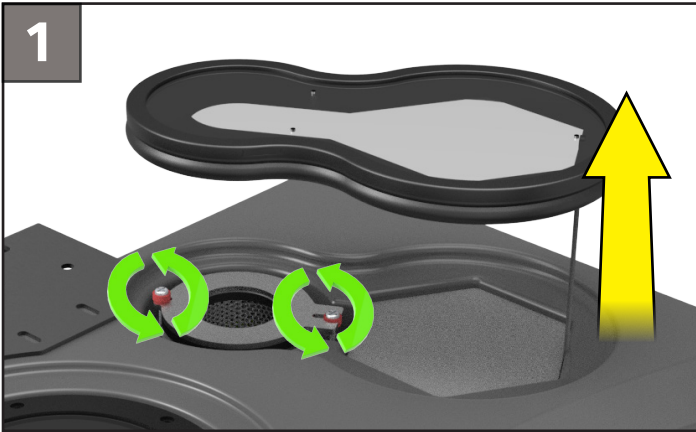

WEEKLY MAINTENANCE (OR 25 HRS)

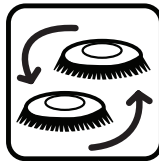

Rotate Disk Brushes

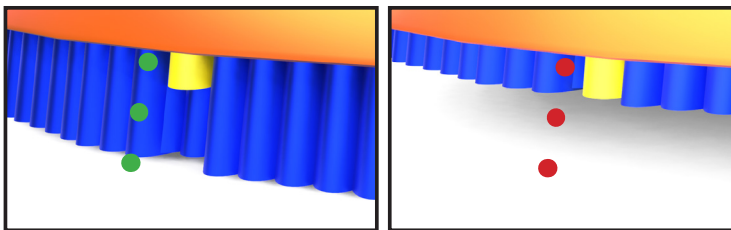
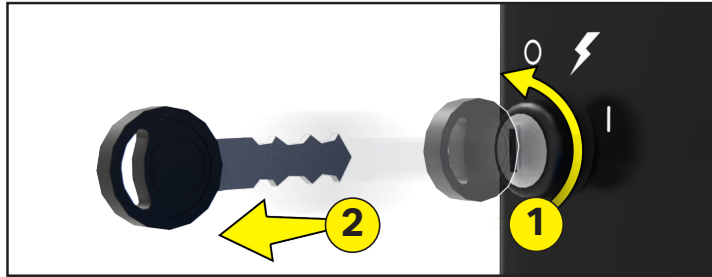

 1/4" (0.5 cm)

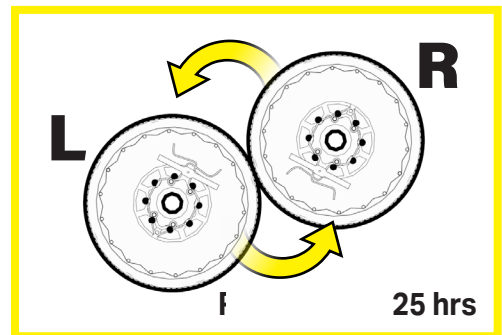

DAILY MAINTENANCE



Clean Cylindrical Hopper

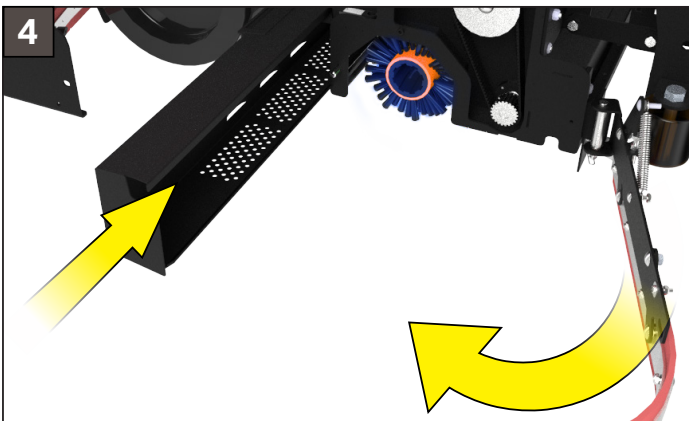
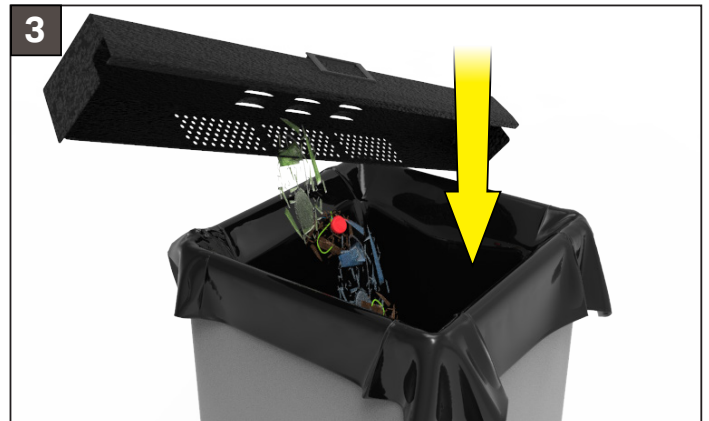
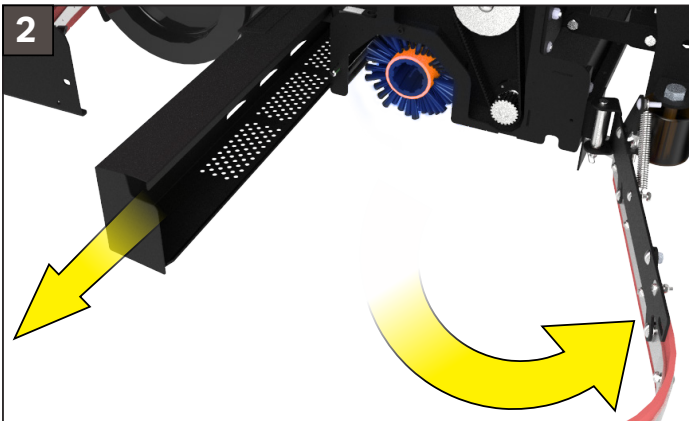
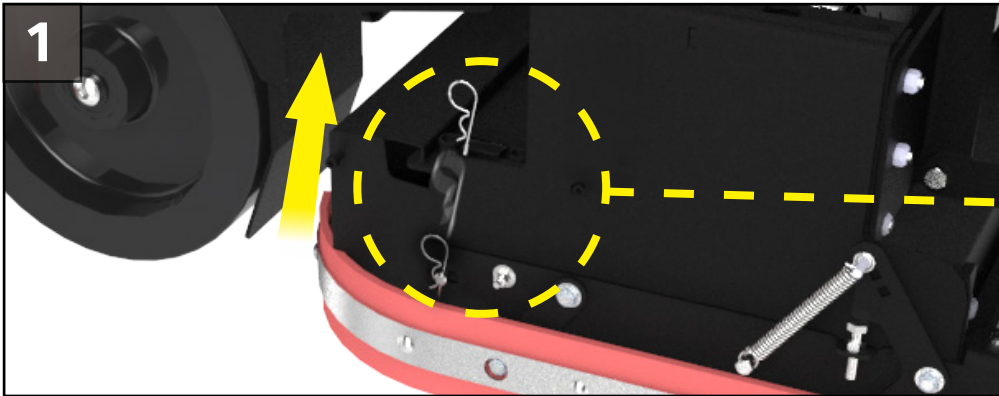
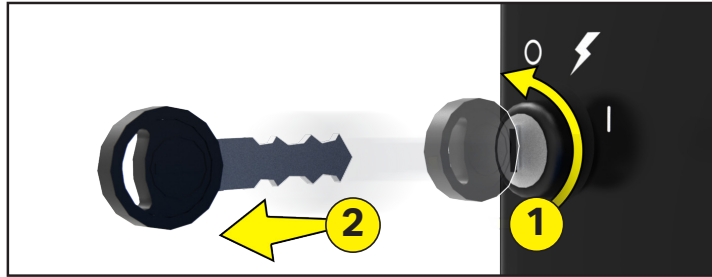



WEEKLY MAINTENANCE (OR 25 HRS)

Clean Solution Filter

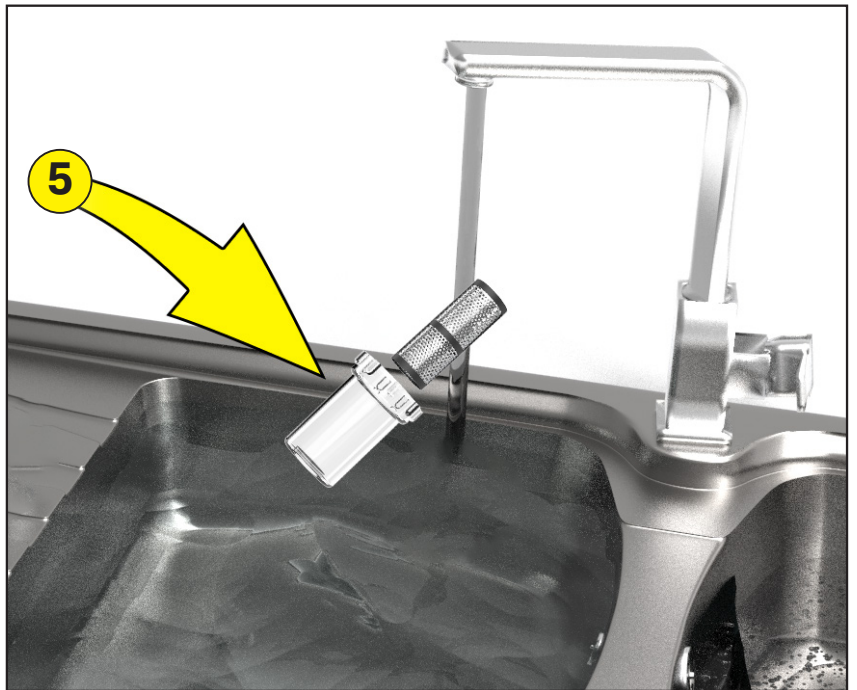
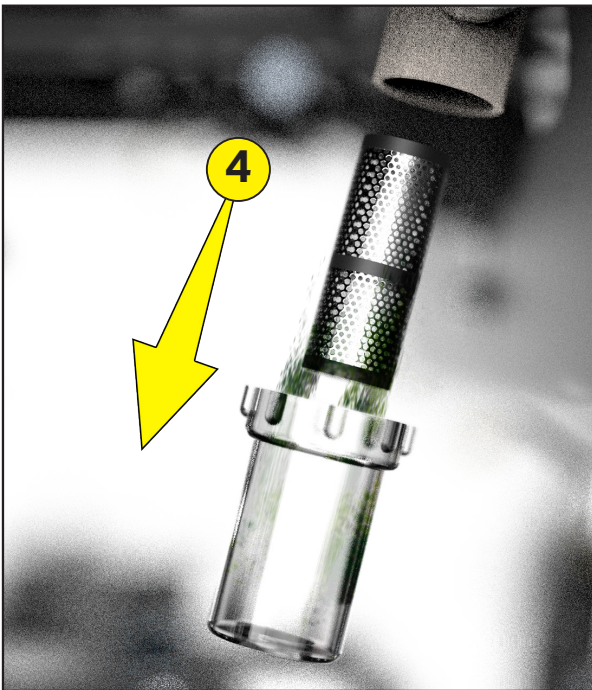
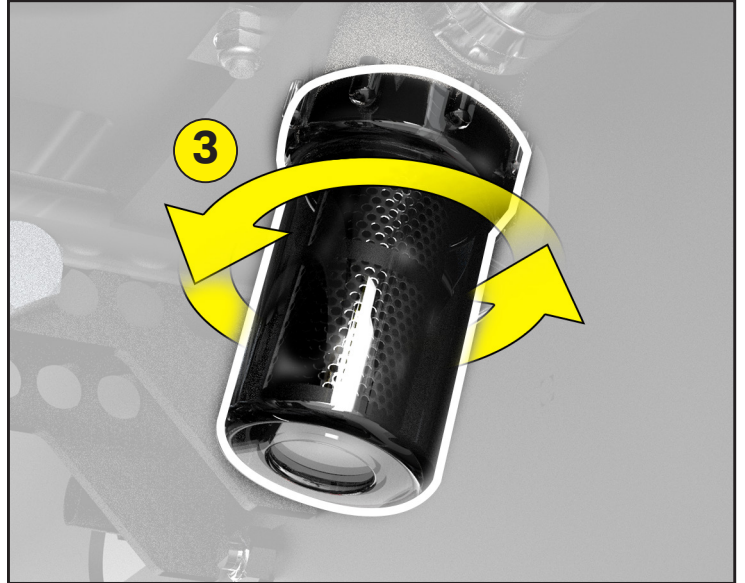
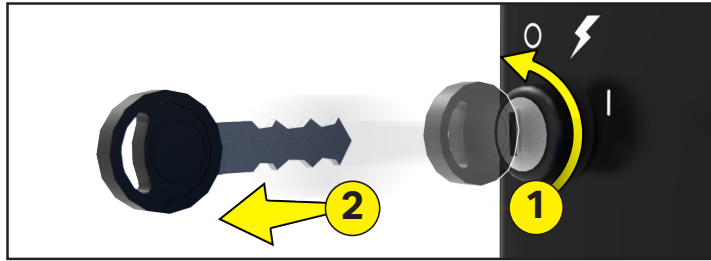

WEEKLY MAINTENANCE (OR 25 HRS)

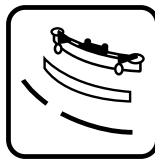

Rotate Squeegee Blade

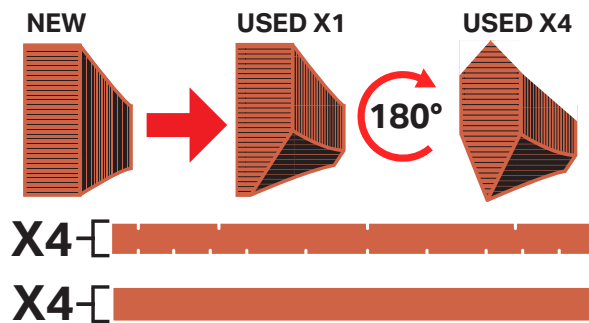
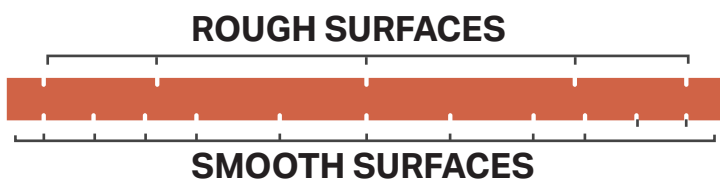
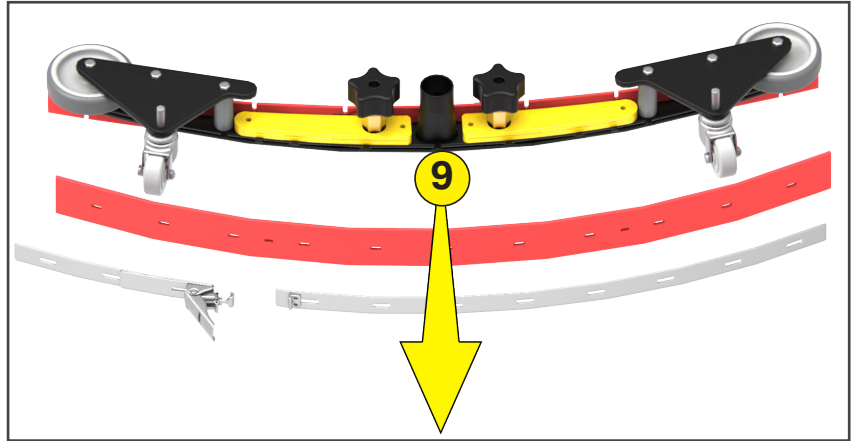
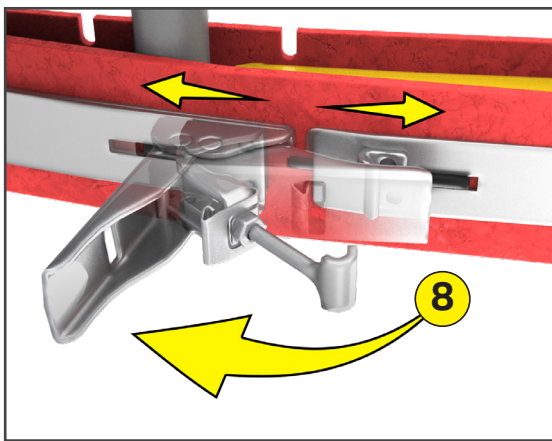
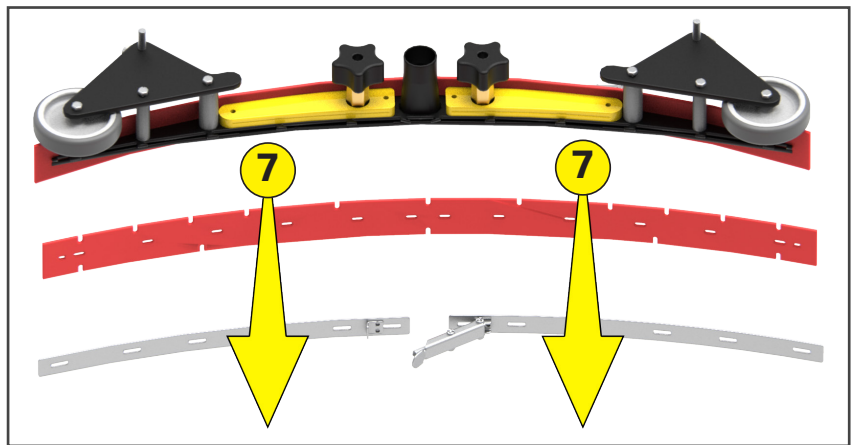
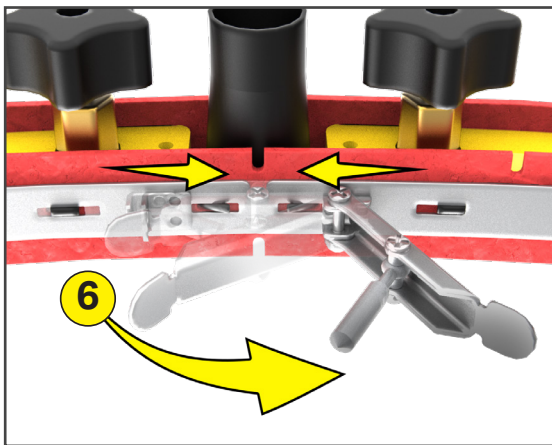
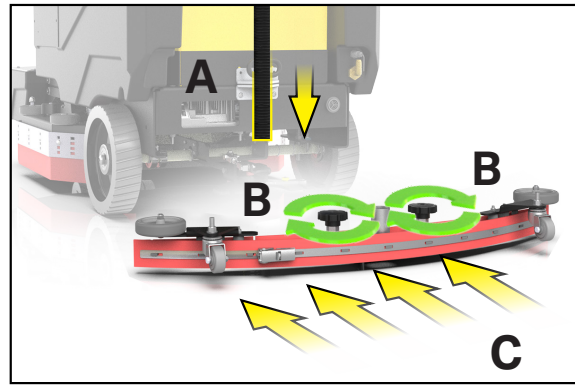
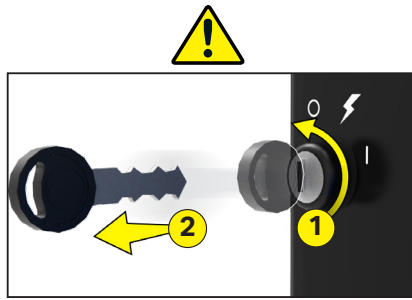



WEEKLY MAINTENANCE (OR 25 HRS)

Drain Solution Tank

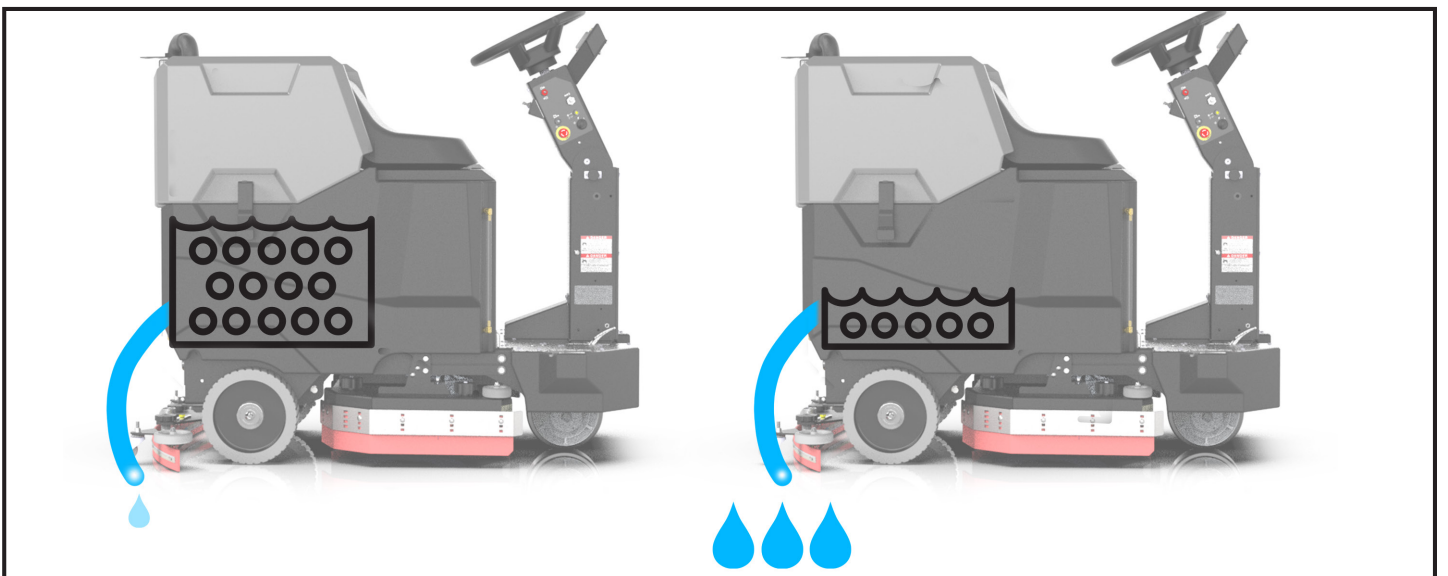
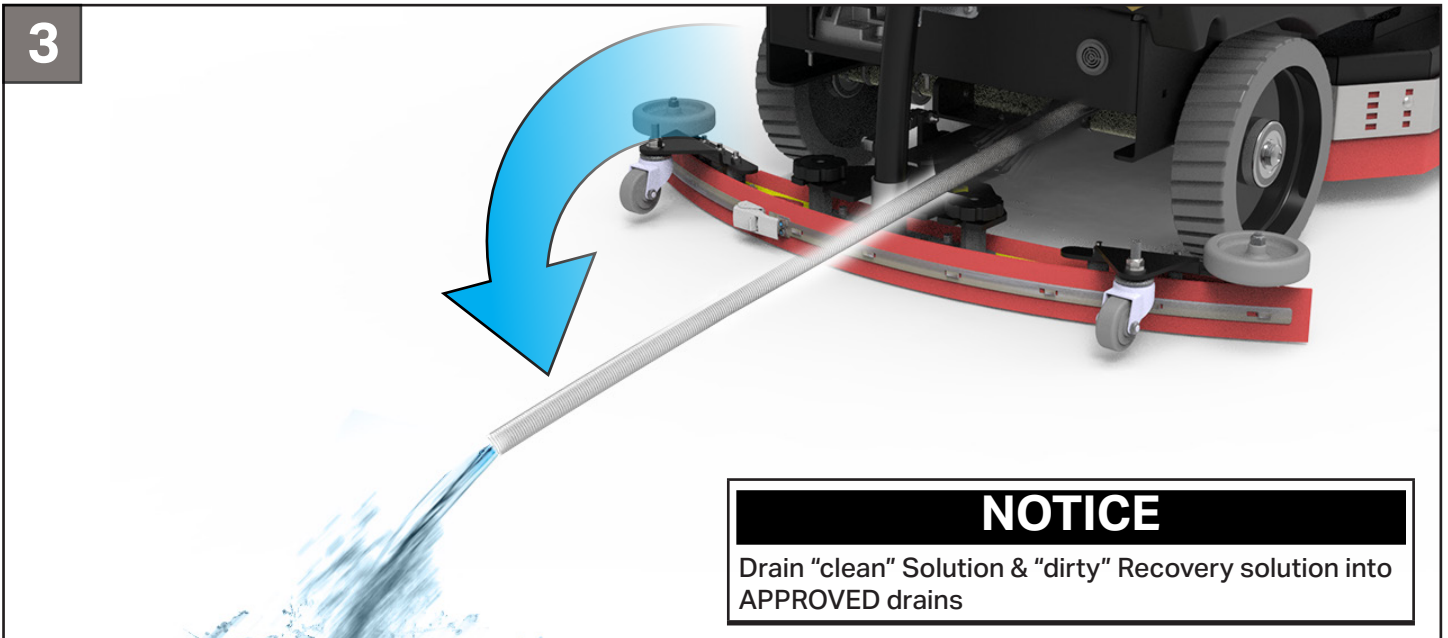
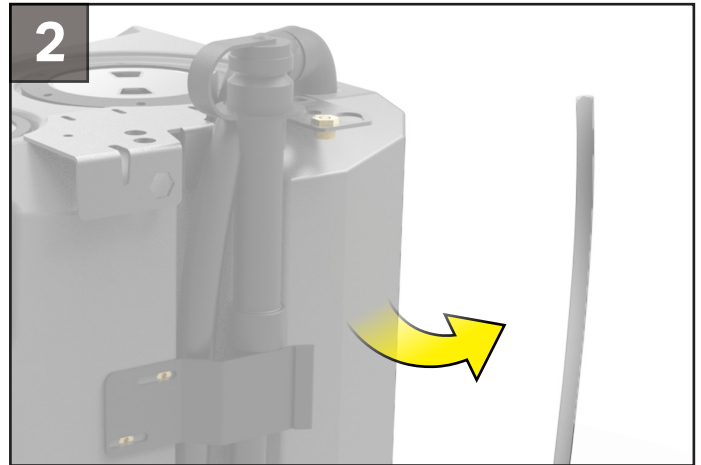
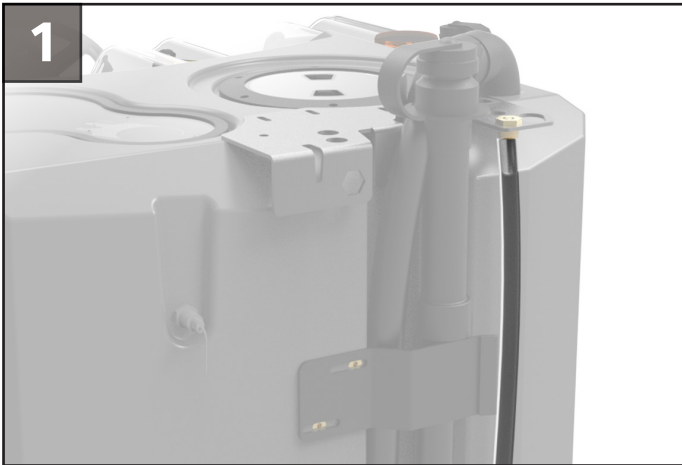

MONTHLY MAINTENANCE (OR 100 HRS)

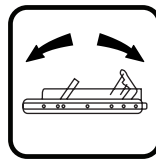

Adjusting Deck Sidewipers

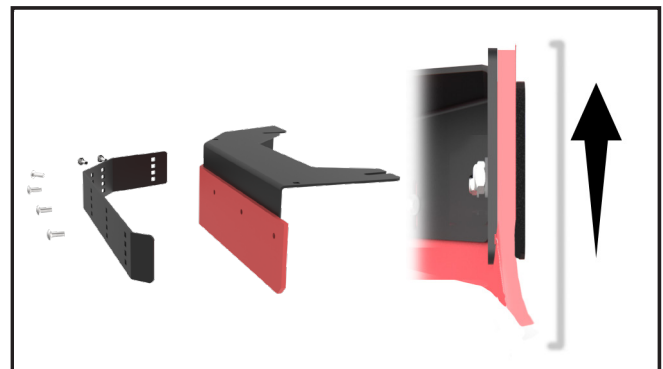
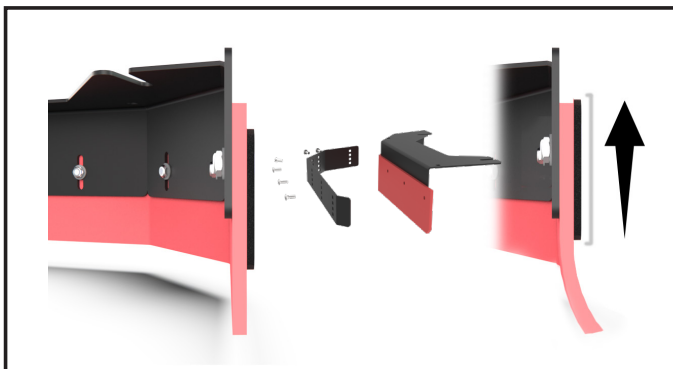
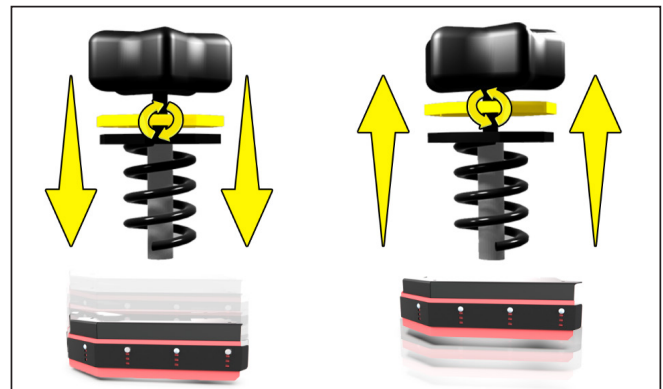
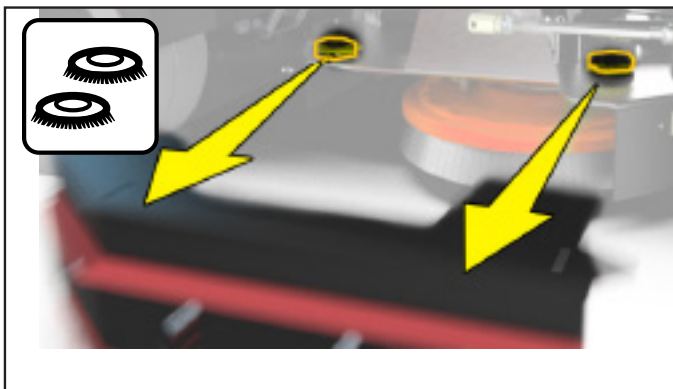
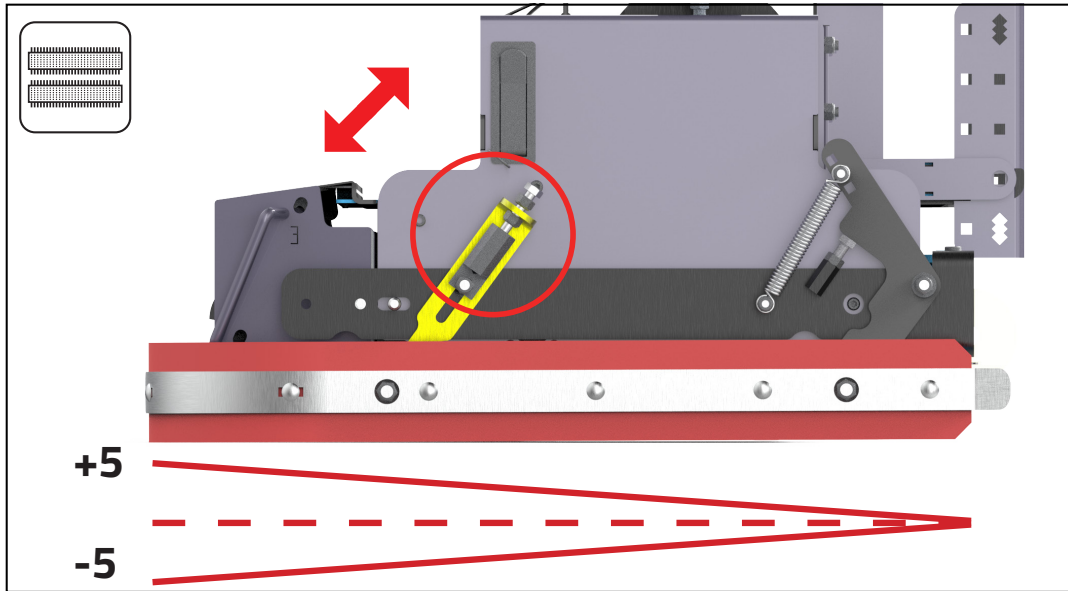
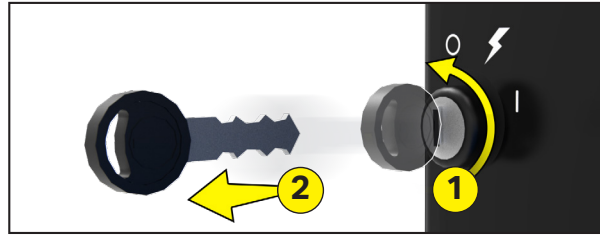

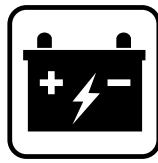

MONTHLY MAINTENANCE (OR 100 HRS)

Battery Water Level

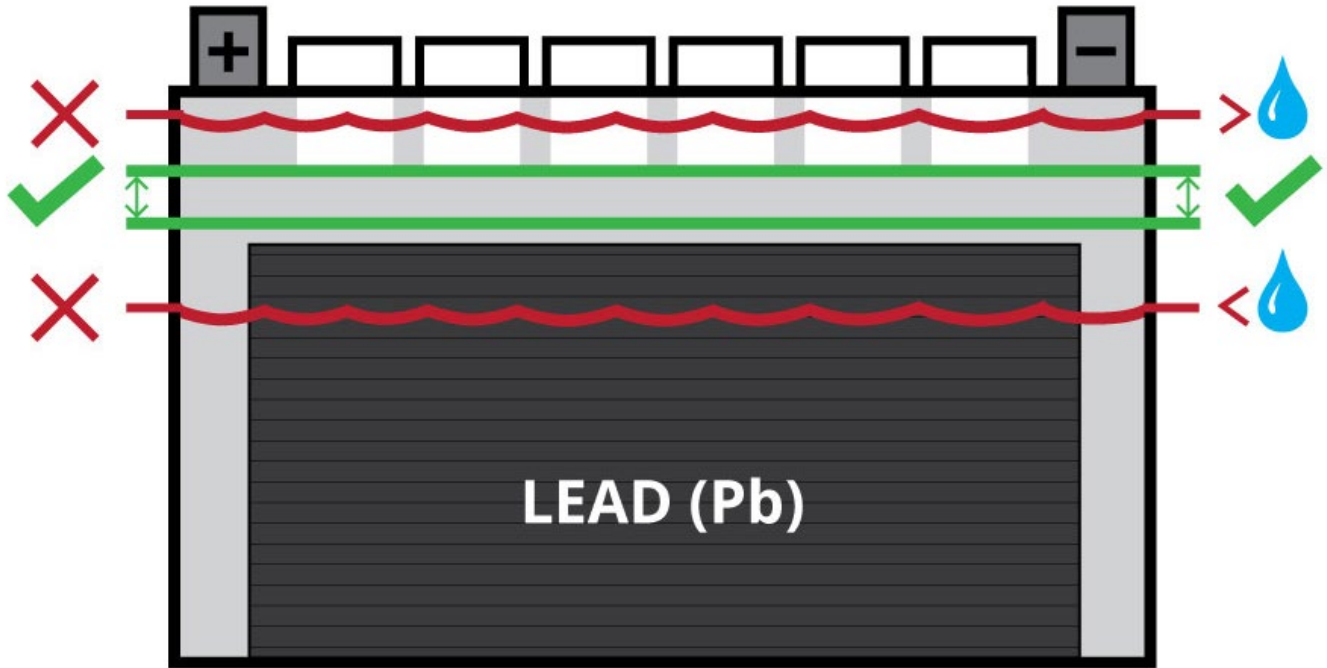



CUSTOMER & MACHINE INFORMATION				
Customer:			Email:	
Address:			Phone:	
City:	State:	Zip:	Contact:	
Serial #:	Model #:		Work Order #:	
Hour Meters	Key Switch:	Transportation:	Scrub Brush:	Vacuum:

NOTE: Start with Machine filled at least with 1/2 Tank of water. Turn ON Machine and Test Functionality of Machine

CHECK OPERATION & CONDITION OF	IN SPEC	REPAIR	PROBLEM
Key Switch			
Deck On / Off – Hold for Down Pressure +/-			
Solution On / Off – Hold for Water Level +/-			
Vac Button ON-OFF (Squeegee - Up/Down) – Hold for ECO			
Green Easy Go Button (Vac/Deck/Solution – On/Off)			
Service Screen Button (Hour Meters/Voltage/Amps)			
Drive Pedal			
Reverse Toggle Switch			
Horn			
E-Stop			
Optional Touch Screen Functioning			

NOTE: Drain Solution & Recovery Tank fully. Rinse out Recovery Tank

CLEAN & INSPECT – SOLUTION TANK	IN SPEC	REPAIR	PROBLEM
Solution Fill Screen - Mesh			
Solution Fill Hose			
Solution Inline Filter			
Battery Drain Hose			

BRUSH CONDITION – SCRUB DECK			
Deck Curtains	Good	Worn	Needs Replacement
Brush Sockets:	Good	Worn	Needs Replacement
Decks Brush Drivers:	Good	Worn	Needs Replacement
Scrub Brush Fiber Length	Brush 1 Length:	Brush 2 Length:	Rotated Brushes: Y / N
Pad Driver	Good	Worn	Needs Replacement
Orbital Deck Teeth	Good	Worn	Needs Replacement

CLEAN & INSPECT – SCRUB DECK	IN SPEC	REPAIR	PROBLEM
Scrub Deck Linkage Pivot Points			
Scrub Deck Lift Actuator			
Scrub Deck Level			
Scrub Motor Wires To Binding Post			

CLEAN & INSPECT - SQUEEGEE	IN SPEC	REPAIR	PROBLEM
Remove and Wipe off Squeegee			
Check and Rotate Blades as Needed			
Caster Wheels and Height			
Pitch Adjust			
Check Pivot, Knobs & Swing Travel			
Squeegee Vac Hose			

CLEAN & INSPECT – RECOVERY TANK	IN SPEC	REPAIR	PROBLEM
Recovery Tank Lid & Gasket			
Recovery Tank Support Cable			
Vacuum Float Ball Screen & Gasket			
Vacuum Box White Filter Clean			
Drain Hose			
Solution Site Tube			
Solution Feed Hoses			
Recovery Tank Strap			

CLEAN & INSPECT – DRIVE	IN SPEC	REPAIR	PROBLEM
Drive & Wheels Condition			
Parking Brake engaged when machine off			

CLEAN & INSPECT - OPTIONS	IN SPEC	REPAIR	PROBLEM
Disinfectant Tank			
100 psi Spray wand			
Dual Head Lights			



BATTERY #1	HYDROMETER READING	WATER CLARITY (Circle One)		WATER LEVEL (Circle One)	
Cell A		Clear	Dark	Overfilled	Full Low
Cell B		Clear	Dark	Overfilled	Full Low
Cell C		Clear	Dark	Overfilled	Full Low
BATTERY #2	HYDROMETER READING	WATER CLARITY (Circle One)		WATER LEVEL (Circle One)	
Cell A		Clear	Dark	Overfilled	Full Low
Cell B		Clear	Dark	Overfilled	Full Low
Cell C		Clear	Dark	Overfilled	Full Low
BATTERY #3	HYDROMETER READING	WATER CLARITY (Circle One)		WATER LEVEL (Circle One)	
Cell A		Clear	Dark	Overfilled	Full Low
Cell B		Clear	Dark	Overfilled	Full Low
Cell C		Clear	Dark	Overfilled	Full Low
BATTERY #4	HYDROMETER READING	WATER CLARITY (Circle One)		WATER LEVEL (Circle One)	
Cell A		Clear	Dark	Overfilled	Full Low
Cell B		Clear	Dark	Overfilled	Full Low
Cell C		Clear	Dark	Overfilled	Full Low

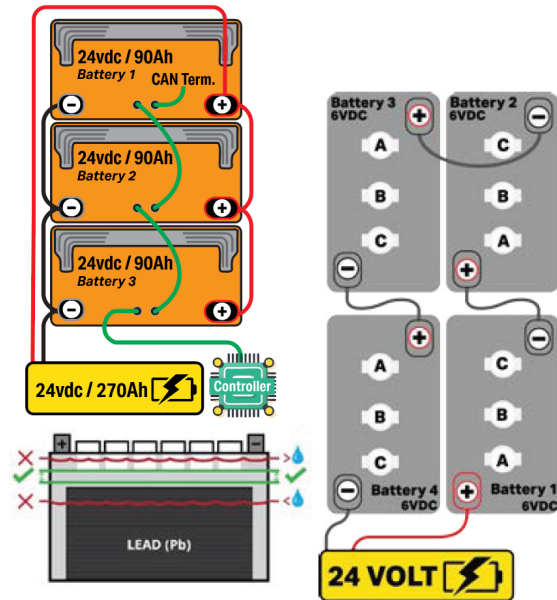

CLEAN & INSPECT - BATTERIES	IN SPEC	REPAIR	PROBLEM
Battery Terminals			
Battery Cables			
Torque Battery Nuts 11ft/lbs			

OPERATE & CONFIRM	IN SPEC	REPAIR	PROBLEM
Fill Solution Tank – ¾ Full			
Scrub & Dry			
Fine Tune Squeegee Adjustments			

COMMENTS & RECOMMENDATIONS

Servicing Distributor:

Technician's Name:	Date:	Signature:
Customer's Name:	Date:	Signature:

OTHER

Battery Chargers

Optional Console / WET / Domestic Chargers:

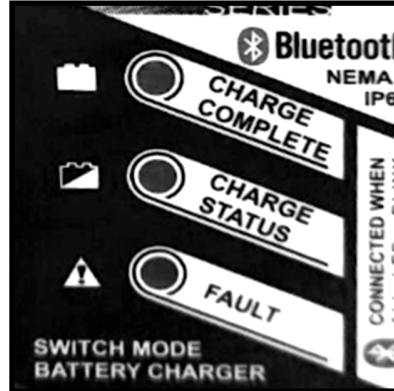

AC Power IN: 120VAC / 60Hz
DC Power OUT: 24VDC / 27A

Please refer to OEM Charger Operating Instructions for more information.



Standard Onboard / AGM / International Chargers:

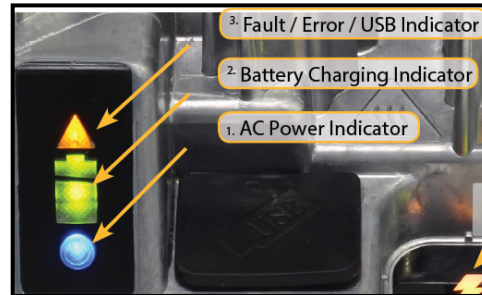
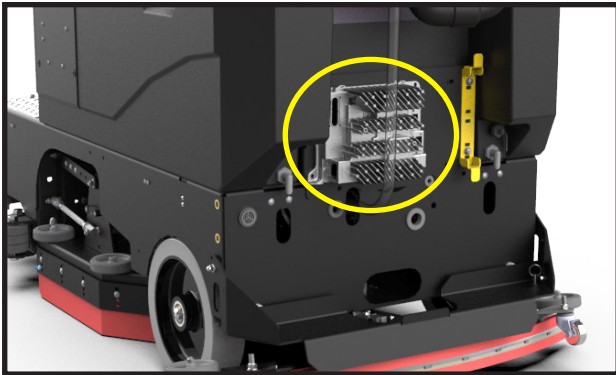

AC Power: 80-270VAC / 50-60Hz
DC Power OUT: 24VDC / 27A + 37A

Please refer to OEM Charger Operating Instructions for more information.



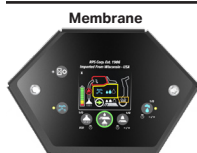

When there is some kind of malfunctioning, the display can show an error with a short description of it.

Whether the error is non-blocking (warning) or blocking, it is displayed as a single line of text in the upper part of the main screen, overriding the hour counter

Following there is the full list of errors and warnings that can appear on the display.

Such errors are divided in 2 tables showing first the blocking ones and non-blocking (warning) next.



Figure 5: Alarm and warning screen example

ERROR NUMBER	ERROR TYPE	ERROR DESCRIPTION	POSSIBLE SOLUTION
3	Blocking	The machine detected too high voltage coming from the battery cables and halted the functions	Check that the battery or the supply of power is around the range of 24V and restart the machine
4	Blocking	The machine detected voltage too low to function correctly and halted the functions	Check that the battery is correctly charged before using it and restart the machine
7	Blocking	The machine detected that the battery is charging and halted the functions	Take out the charging cable before using the machine
10	Blocking	It has passed too much time since someone touched the machine and it entered the standby mode	Restart the machine
211	Blocking	The Orion detected the potentiometer out of the allowed range	Check the potentiometer cables and the parameters value
214	Blocking	The Orion detected a temperature too high on the motors and halted the functions	Make the machine cool down for a bit and check the Orion board for any possible issue that could cause a temperature rising
230	Non blocking	There is some condition preventing the machine from starting, depending on which controls are enabled at startup	Release the pedal or the OPC input
40, 240	Blocking	There are issues between the Orion and Display CANbus communication	Check the CANbus cable and the resistance parameter on each board
250	Blocking	The traction drivers detected a current spike too high and halted the functionalities related to said motor	Check the cable and the motor itself and restart the machine
251	Blocking	The traction maximum current was too high for too much time and the functionalities were halted	Check the motor and the cables as well as the I2T parameters if everything is correct and restart the machine

OTHER

Membrane

Membrane



253	Blocking	The traction current limitation went on for too much time and the functionalities were halted	Check if the current parameters are correct and restart the machine
254	Blocking	The Orion did not detect the traction motor at startup	Check the wirings and restart the machine
256	Blocking	The battery reached its minimum value of charge and the traction was halted to prevent wearing	Recharge the battery
290	Non blocking	The brushes drivers detected a current spike too high and halted the functionalities related to said motor	Check the cable and the motor itself and restart the machine
291	Non blocking	The brushes maximum current was too high for too much time and the functionalities were halted	Check the motor and the cables as well as the I2T parameters if everything is correct and restart the machine
293	Blocking	The brushes current limitation went on for too much time and the functionalities were halted	Check if the current parameters are correct and restart the machine
296	Non blocking	The battery reached its minimum value of charge and the brushes were halted to prevent wearing	Recharge the battery
310	Non blocking	The vacuum drivers detected a current spike too high and halted the functionalities related to said motor	Check the cable and the motor itself and restart the machine
311	Non blocking	The vacuum maximum current was too high for too much time and the functionalities were halted	Check the motor and the cables as well as the I2T parameters if everything is correct and restart the machine
313	Blocking	The vacuum current limitation went on for too much time and the functionalities were halted	Check if the current parameters are correct and restart the machine
316	Non blocking	The battery reached its minimum value of charge and the vacuum was halted to prevent wearing	Recharge the battery



Pg 1 of 3

Error	Internal Label	Code	Type	Description	Action	Remedy
Vacuum motor current over software limit	VACUUM_SOFTWARE_OV	49	soft	The vacuum motor current has exceed the software limit	The vacuum motor is disabled	
Squeegee motor current over hardware limit	SQUEE_HARDWARE_OV	50	soft	The squeegee motor current has exceed the absolute hardware limit	The squeegee actuator is disabled	
	VALVE_FAULT	51				
Open circuit detected in vacuum motor	VACUUM_OPEN_CIRCUIT	52	soft	An electrically open condition has been detected in the vacuum motor circuit	The vacuum motor is disabled	
	TRACT_RIGHT_NULL_ERROR	53				
	TRACTION_OPEN_CIRCUIT	54				
Open circuit detected in deck actuator	BRUSH_DECK_OPEN_CIRCUIT	55	soft	An electrically open condition has been detected in the deck actuator circuit	Brush, deck actuator and water/suds are disabled	
	TRAIL_TIME_OUT	56				
	SOLENOID_WELDED_OTHER	57				
	SOLENOID_CLOSE_LIMIT_WARNING	58				
Squeegee motor stalled	SQUEE_STALLED_MOTOR	59	soft	An energized squeegee actuator is not moving	The squeegee actuator is disabled	
Deck actuator stalled	BRU_DECK_STALLED_MOTOR	60	soft	An energized deck actuator is not rotating	Brush, deck actuator and water/suds are disabled	
	PRECHARGE_FAILURE_OTHER	61				
Brush motor stalled	BRUSH_STALLED_MOTOR	62	soft	An energized brush motor is not rotating	Brush, deck actuator and water/suds are disabled	
vacuum motor stalled	VACUUM_STALLED_MOTOR	63	soft	An energized vacuum motor is not rotating	The vacuum motor is disabled	
	LEFT_CURRENT_LIMIT	64				
	RIGHT_CURRENT_LIMIT	65				
Overheat MOSFET	THERMAL_CUTBACK_MOS	66	hard	The transport motor drive circuit has had an over temperature failure	The machine is disabled	
Battery over voltage	HIGH_BATTERY_PROTECT	67	hard	The battery voltage is above acceptable limits	The machine is disabled	check batteries / wiring

ERROR CODES

Touch Screen (Optional)

Pg 2 of 3

Error	Internal Label	Code	Type	Description	Action	Remedy
	HARD_FAULT	0		Flag used to define a show-stop-per failure requiring a power cycle		
	SOFT_FAULT	1		Flag used to define an error that may disable a device but keep the rest of the machine operational		
	NO_ERROR	0		Used internally		
Bad Personality	BAD_PERSONALITY	10	hard/soft	Incompatible options programmed or a checksum failure	The machine is disabled or continues operating with factory default parameters	Check programming options and/or reprogram EEPROM
Initial throttle fault	INITIAL_THROTTLE_FAULT	11	soft	Throttle is engaged at power up preventing a successful return to idle state	Machine remains in a pre-idle condition until the active throttle condition goes away	Take your foot off the gas
	SHORT_CIRCUIT	12	hard			
Memory fault	EEPROM_READ_ERROR	13	hard/soft	An error was detected during an EEPROM read access	The machine is disabled or continues operating with factory default parameters	Cycle keyswitch. If problem persists change control board
Dead battery	LOW_BATTERY_PROTECT	14	hard	The battery voltage has dropped below NN.n Volts	The machine is disabled	Charge or replace batteries
Low battery charge	LOW_BATTERY_CHARGE	15	soft	The battery voltage has dropped below NN.n Volts and all but the transport motor have been disabled	All but the transport motor are disabled	Charge battery
Overheat CPU	THERMAL_CUTBACK_MCU	16	hard	The microcontroller hardware has had an over temperature failure	The controller is switched off	Keyswitch off, wait ten minutes, keyswitch on. If problem persists change control board
	PRECHARGE_FAILURE_TRA	17				
Transport idle current fault	TRACT_LEFT_NULL_ERROR	18	hard	An abnormally high idle current has been detected in the transport motor (operational motor)	The machine is disabled	
Brush idle current fault	BRUSH_NULL_ERROR	19	soft	An abnormally high idle current has been detected in the brush motor (operational motor)	Brush, deck actuator and water/suds are disabled	
Vacuum idle current fault	VACUUM_NULL_ERROR	20	soft	An abnormally high idle current has been detected in the vacuum motor (operational motor)	Vacuum motor is disabled	
Squeegee idle current fault	SQUEEGEE_NULL_ERROR	21	soft	An abnormally high idle current has been detected in the squeegee motor (operational motor)	Squeegee motor is disabled	
	BRU_ADJ_OUT_OF_RANGE	22	soft			
Transport motor relay not open	SOLENOID_WELDED_TRA	23	hard	The main traction relay was detected closed during power on	The machine is disabled	Keyswitch off, wait ten seconds, keyswitch on. If problem persists change control board
Transport motor relay not closed	SOLENOID_DIDNT_CLOSE_TRA	24	hard	The main traction relay was detected open after being energized during power on	The machine is disabled	
Throttle fault	THROTTLE_FAULT	25	hard	An illegal voltage has been read from the throttle feedback circuit	The machine is disabled	Check throttle action and voltages

Error	Internal Label	Code	Type	Description	Action	Remedy
Brake fault	BRAKE_FAULT	26	hard	An illegal voltage has been read from the brake feedback circuit	The machine is disabled	
Alarm fault	ALARM_FAULT	27	soft			
Auxilliary output 1 fault	AUX_1_FAULT	28	soft			
Auxilliary output 2 fault	AUX_2_FAULT	29	soft			
Auxilliary output 3 fault	AUX_3_FAULT	68	soft			
Deck actuator idle current over limit	BRU_DECK_NULL_ERROR	30	soft	An abnormally high idle current has been detected in the deck actuator motor	Brush, deck actuator and water/suds are disabled	
Transport motor stalled	TRACTION_STALLED_MOTOR	31	hard	An energized transport motor is not rotating		
Transport motor circuit current over limit	LEFT_DRAIN_OV	32	hard	There is excessive current in the transport motor drive circuit		
Transport motor circuit current over limit	RIGHT_DRAIN_OV	33	hard	There is excessive current in the transport motor drive circuit	The machine is disabled	
Brush motor current over software limit	BRUSH_SOFTWARE_OV	34	soft	The brush motor current has exceed the software limit	Brush, deck actuator and water/suds are disabled	
Brush motor current over hardware limit	BRUSH_HARDWARE_OV	35	soft	The brush motor current has exceed the absolute hardware limit	Brush, deck actuator and water/suds are disabled	
Open circuit detected in brush motor	BRUSH_OPEN_CIRCUIT	36	soft	An electrically open condition has been detected in the brush motor circuit	Brush, deck actuator and water/suds are disabled	
	REGEN_CURRENT_EXCEEDED	37				
	LEFT_DRAIN_FAULT	38				
	RIGHT_DRAIN_FAULT	39				
Transport motor current over hardware limit	LEFT_SOFTWARE_OV	40	hard	The transport motor current has exceed the absolute hardware limit	The machine is disabled	
Transport motor current over hardware limit	RIGHT_SOFTWARE_OV	41	hard	The transport motor current has exceed the absolute hardware limit	The machine is disabled	
	BRUSH_DRAIN_FAULT	42				
12VDC power supply outside acceptable limits	SUPPLY_OUT_OF_RANGE	43	hard	The 12VDC supply voltage is less tha 11.75V or greater than 12.25 volts	The machine is disabled	check batteries
	VALVE_OPEN_CIRCUIT	44				
Deck actuator motor current over software limit	BRU_DECK_SOFTWARE_OV	45	soft	The deck actuator current has exceed the software limit	Brush, deck actuator and water/suds are disabled	
Vacuum motor current over hardware limit	VACUUM_HARDWARE_OV	46	soft	The vacuum motor current has exceed the software limit	The vacuum motor is disabled	
Deck actuator motor current over hardware limit	BRU_DECK_HARDWARE_OV	47	soft	The deck actuator current has exceed the absolute hardware limit	Brush, deck actuator and water/suds are disabled	
Squeegee motor current over software limit	SQUEE_SOFTWARE_OV	48	soft	The squeegee motor current has exceed the software limit	The squeegee actuator is disabled	

BLANK

THIS PAGE WAS INTENTIONALLY LEFT BLANK

